

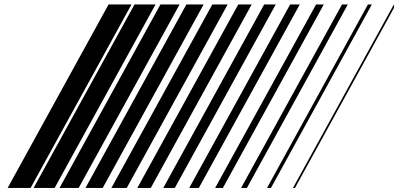

JVC



VIDEO CASSETTE RECORDER

HR-S5300U

ENGLISH

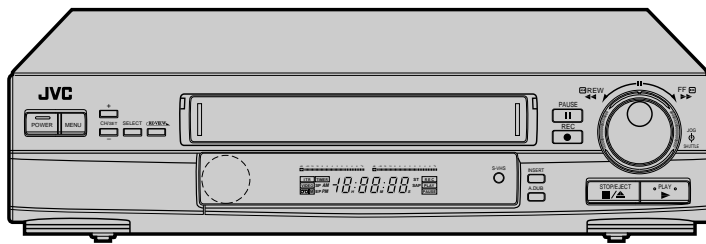
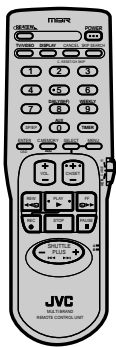

VCR Plus[®] C³
w/Cable Channel
Changer

Hi-Fi SVHS

INSTRUCTIONS

For Customer Use:

Enter below the Serial No. which is located on the rear of cabinet. Retain this information for future reference.

Model No. **HR-S5300U**

Serial No. _____



EN

PU30425-1826-1

Dear Customer,

Thank you for purchasing the JVC VHS video cassette recorder. Before use, please read the safety information and precautions contained in the following pages to ensure safe use of your new VCR.

CAUTIONS

	CAUTION RISK OF ELECTRIC SHOCK DO NOT OPEN	
<p>CAUTION: TO REDUCE THE RISK OF ELECTRIC SHOCK, DO NOT REMOVE COVER (OR BACK). NO USER-SERVICEABLE PARTS INSIDE. REFER SERVICING TO QUALIFIED SERVICE PERSONNEL.</p>		



The lightning flash with arrowhead symbol, within an equilateral triangle, is intended to alert the user to the presence of uninsulated "dangerous voltage" within the product's enclosure that may be of sufficient magnitude to constitute a risk of electric shock to persons.



The exclamation point within an equilateral triangle is intended to alert the user to the presence of important operating and maintenance (servicing) instructions in the literature accompanying the appliance.

WARNING:

TO PREVENT FIRE OR SHOCK HAZARD, DO NOT EXPOSE THIS UNIT TO RAIN OR MOISTURE.

CAUTION:

This video cassette recorder should be used with AC 120V~, 60Hz only. To prevent electric shocks and fire hazards, DO NOT use any other power source.

CAUTION:

TO PREVENT ELECTRIC SHOCK, MATCH WIDE BLADE OF PLUG TO WIDE SLOT, FULLY INSERT.

ATTENTION:

POUR ÉVITER LES CHOCS ÉLECTRIQUES, INTRODUIRE LA LAME LA PLUS LARGE DE LA FICHE DANS LA BORNE CORRESPONDANTE DE LA PRISE ET POUSSER JUSQU'AU FOND.

Note to CATV system installer:

This reminder is provided to call the CATV system installer's attention to Article 820-40 of the NEC that provides guidelines for proper grounding and, in particular, specifies that the cable ground shall be connected to the grounding system of the building, as close to the point of cable entry as practical.

CAUTION:

Changes or modifications not approved by JVC could void user's authority to operate the equipment.

Failure to heed the following precautions may result in damage to the VCR, remote control or video cassette.

- DO NOT** place the VCR . . .
 - ... in an environment prone to extreme temperatures or humidity.
 - ... in direct sunlight.
 - ... in a dusty environment.
 - ... in an environment where strong magnetic fields are generated.
 - ... on a surface that is unstable or subject to vibration.
- DO NOT** block the VCR's ventilation openings.
- DO NOT** place heavy objects on the VCR or remote control.
- DO NOT** place anything which might spill on top of the VCR or remote control.
- AVOID** violent shocks to the VCR during transport.

****MOISTURE CONDENSATION**

Moisture in the air will condense on the VCR when you move it from a cold place to a warm place, or under extremely humid conditions—just as water droplets form on the surface of a glass filled with cold liquid. Moisture condensation on the head drum will cause damage to the tape. In conditions where condensation may occur, keep the VCR's power turned on for a few hours to let the moisture dry before inserting a tape.

****ABOUT HEAD CLEANING**

Accumulation of dirt and other particles on the video heads may cause the playback picture to become blurred or interrupted. Be sure to contact your nearest JVC dealer if such troubles occur.

VCR Plus+C³ and PlusCode are trademarks of Gemstar Development Corporation.

The VCR Plus+C³ system is manufactured under licence from Gemstar Development Corporation.

DSS™ is an official trademark of DIRECTV, Inc., a unit of GM Hughes Electronics.



- Cassettes marked "S-VHS" and "VHS" can be used with this video cassette recorder. However, S-VHS recordings are possible only with cassettes marked "S-VHS".

IMPORTANT PRODUCT SAFETY INSTRUCTIONS

Electrical energy can perform many useful functions. But improper use can result in potential electrical shock or fire hazards. This product has been engineered and manufactured to assure your personal safety. In order not to defeat the built-in safeguards, observe the following basic rules for its installation, use and servicing.

ATTENTION:

Follow and obey all warnings and instructions marked on your product and its operating instructions. For your safety, please read all the safety and operating instructions before you operate this product and keep this booklet for future reference.

INSTALLATION

1. Grounding or Polarization

(A) Your product may be equipped with a polarized alternating-current line plug (a plug having one blade wider than the other). This plug will fit into the power outlet only one way. This is a safety feature.

If you are unable to insert the plug fully into the outlet, try reversing the plug. If the plug should still fail to fit, contact your electrician to replace your obsolete outlet. Do not defeat the safety purpose of the polarized plug.

(B) Your product may be equipped with a 3-wire grounding-type plug, a plug having a third (grounding) pin. This plug will only fit into a grounding-type power outlet. This is a safety feature.

If you are unable to insert the plug into the outlet, contact your electrician to replace your obsolete outlet. Do not defeat the safety purpose of the grounding-type plug.

2. Power Sources

Operate your product only from the type of power source indicated on the marking label. If you are not sure of the type of power supply to your home, consult your product dealer or local power company. If your product is intended to operate from battery power, or other sources, refer to the operating instructions.

3. Overloading

Do not overload wall outlets, extension cords, or integral convenience receptacles as this can result in a risk of fire or electric shock.

4. Power Cord Protection

Power supply cords should be routed so that they are not likely to be walked on or pinched by items placed upon or against them, paying particular attention to cords at plugs, convenience receptacles, and the point where they exit from the product.

5. Ventilation

Slots and openings in the cabinet are provided for ventilation. To ensure reliable operation of the product and to protect it from overheating, these openings must not be blocked or covered.

- Do not block the openings by placing the product on a bed, sofa, rug or other similar surface.
- Do not place the product in a built-in installation such as a bookcase or rack unless proper ventilation is provided or the manufacturer's instructions have been adhered to.

6. Wall or Ceiling Mounting

The product should be mounted to a wall or ceiling only as recommended by the manufacturer.

ANTENNA INSTALLATION INSTRUCTIONS

1. Outdoor Antenna Grounding

If an outside antenna or cable system is connected to the product, be sure the antenna or cable system is grounded so as to provide some protection against voltage surges and built-up static charges. Article 810 of the National Electrical Code, ANSI/NFPA 70, provides information with regard to proper grounding of the mast and supporting structure, grounding of the lead-in wire to an antenna discharge unit, size of grounding connectors, location of antenna discharge unit, connection to grounding electrodes, and requirements for the grounding electrode.

2. Lightning

For added protection for this product during a lightning storm, or when it is left unattended and unused for long periods of time, unplug it from the wall outlet and disconnect the antenna or cable system. This will prevent damage to the product due to lightning and power-line surges.

3. Power Lines

An outside antenna system should not be located in the vicinity of overhead power lines or other electric light or power circuits, or where it can fall into such power lines or circuits. When installing an outside antenna system, extreme care should be taken to keep from touching such power lines or circuits as contact with them might be fatal.

EXAMPLE OF ANTENNA GROUNDING AS PER NATIONAL ELECTRICAL CODE, ANSI/NFPA 70

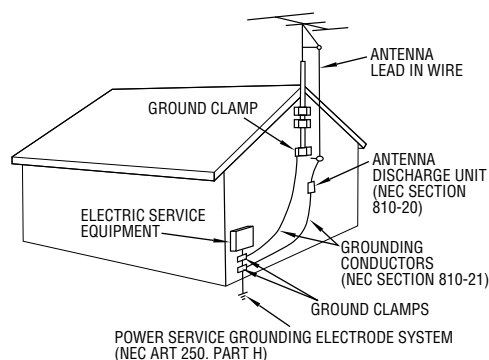

NEC - NATIONAL ELECTRICAL CODE



4

USE

1. Accessories

To avoid personal injury:

- Do not place this product on an unstable cart, stand, tripod, bracket, or table. It may fall, causing serious injury to a child or adult, and serious damage to the product.
- Use only with a cart, stand, tripod, bracket, or table recommended by the manufacturer or sold with the product.
- Use a mounting accessory recommended by the manufacturer and follow the manufacturer's instructions for any mounting of the product.
- Do not try to roll a cart with small casters across thresholds or deep-pile carpets.

2. Product and Cart Combination

A product and cart combination should be moved with care. Quick stops, excessive force, and uneven surfaces may cause the product and cart combination to overturn.

PORTABLE CART WARNING
(Symbol provided by RETAC)



3. Water and Moisture

Do not use this product near water—for example, near a bath tub, wash bowl, kitchen sink or laundry tub, in a wet basement, or near a swimming pool and the like.

4. Object and Liquid Entry

Never push objects of any kind into this product through openings as they may touch dangerous voltage points or short-out parts that could result in a fire or electric shock. Never spill liquid of any kind on the product.

5. Attachments

Do not use attachments not recommended by the manufacturer of this product as they may cause hazards.

6. Cleaning

Unplug this product from the wall outlet before cleaning. Do not use liquid cleaners or aerosol cleaners. Use a damp cloth for cleaning.

7. Heat

The product should be situated away from heat sources such as radiators, heat registers, stoves, or other products (including amplifiers) that produce heat.

SERVICING

1. Servicing

If your product is not operating correctly or exhibits a marked change in performance and you are unable to restore normal operation by following the detailed procedure in its operating instructions, do not attempt to service it yourself as opening or removing covers may expose you to dangerous voltage or other hazards. Refer all servicing to qualified service personnel.

2. Damage Requiring Service

Unplug this product from the wall outlet and refer servicing to qualified service personnel under the following conditions:

- When the power supply cord or plug is damaged.
- If liquid has been spilled, or objects have fallen into the product.
- If the product has been exposed to rain or water.
- If the product does not operate normally by following the operating instructions. Adjust only those controls that are covered by the operating instructions as an improper adjustment of other controls may result in damage and will often require extensive work by a qualified technician to restore the product to its normal operation.
- If the product has been dropped or damaged in any way.
- When the product exhibits a distinct change in performance—this indicates a need for service.

3. Replacement Parts

When replacement parts are required, be sure the service technician has used replacement parts specified by the manufacturer or have the same characteristics as the original part. Unauthorized substitutions may result in fire, electric shock or other hazards.

4. Safety Check

Upon completion of any service or repairs to this product, ask the service technician to perform safety checks to determine that the product is in safe operating condition.

HOW TO USE THIS INSTRUCTION MANUAL

- All major sections and subsections are listed in the Table Of Contents on page 5. Use this when searching for information on a specific procedure or feature.
- The Index on pages 61–63 lists frequently-used terms, and the number of the first page on which they are used or explained in the manual. This section also illustrates the controls and connections on the front and rear panel, the front display panel and the remote control.
- The mark signals a reference to another page for instructions or related information.
- Operation buttons necessary for the various procedures are clearly indicated through the use of illustrations at the beginning of each major section.

BEFORE YOU INSTALL YOUR NEW VCR . . .

. . . please read the sections/literature listed below.

- "Cautions" on page 2
- "Important Products Safety Instructions" on the previous pages



CONTENTS

I NSTALLING YOUR NEW VCR **6**

Connections	6
Basic Connections	6
S-VIDEO Connection	7

I NITIAL SETTINGS **8**

Clock	8
Advanced Auto Clock Set	8
Clock Setting	9
Preparation	9
Semi-Auto	10
Manual	11
Auto	11
Language	12
Tuner	13
Set Receivable Channels	13
Add Or Delete A Channel	15
Tuner And Cable Box Controller	16
Situate And Connect Controller	16
Set Cable Box Output Channel	17
Set Cable Box Brand	18
VCR Plus+ Setup	20

S IMPLE PLAYBACK AND RECORDING **23**

Simple Playback	23
Simple Recording	24

P LAYBACK AND RECORDING FEATURES **25**

Playback	25
Still Picture/Frame-By-Frame Playback	25
Slow Motion/Reverse Slow Motion	25
Variable-Speed Search/Reverse Motion Playback	26
High-Speed Search	26
Manual Tracking	27
Skip Search	27
Repeat Playback	27
Select The Soundtrack	28
Superimpose	29
Index Search	30
Manual Index Mark/Eraser	30
Instant ReView	31
Counter Reset	31
Counter Memory	31
Next-Function Memory	32
AV COMPU LINK Playback	32
Recording	34
Record One Program While Watching Another	34
Display Elapsed Recording Time	34
S-VHS (Super VHS) and VHS	34
Stereo And SAP (Second Audio Program)	35
To Record SAP Programs	35
Hi-Fi Audio Recording Level Control	36
Display Tape Remaining Time	37

T IMER RECORDING **38**

VCR Plus+ Timer Programming	38
Instant Timer Recording (ITR)	40
On-Screen Timer Programming	40
Check And Cancel Programs	42
Auto Timer	43

E DITING **44**

Edit From A Camcorder	44
Edit To Or From Another VCR	46
Assemble Editing	47
Insert Editing	48
Random Assemble Editing	50
Audio Dubbing	52

S PECIAL FEATURES **53**

TV Multi-Brand Remote Control	53
Cable Box Multi-Brand Remote Control	54
DSS Receiver Multi-Brand Remote Control	55
Control Two JVC VCRs	55

T ROUBLESHOOTING **56**

Power	56
Tape Transport	56
Playback	56
Recording	57
Timer Recording	57
Other Problems	58

Q UESTIONS AND ANSWERS **59**

Playback	59
Recording	59
Timer Recording	59

S PECIALIFICATIONS **60**

I NDEX **61**

List Of Terms	61
Front View	62
Rear View	62
Front Display Panel	63
Remote Control	63

F OR SERVICING **64**

W ARRANTY **65**

Connections

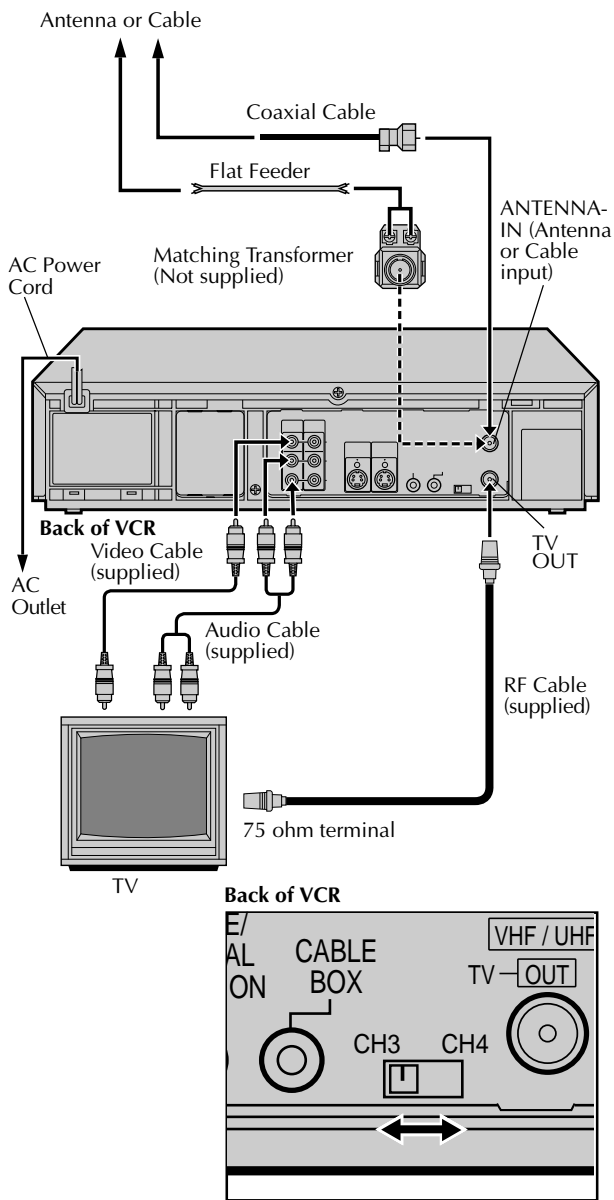

Basic Connections

1 CHECK CONTENTS

Make sure the package contains all of the accessories listed in "SPECIFICATIONS" (☞ pg. 60).

2 SITUATE VCR

Place the VCR on a stable, horizontal surface.

3 CONNECT VCR TO TV

The connection method you use depends on the type of TV you have.

RF Connection

- To Connect To A TV With NO AV Input Terminals . . .
 - a- Disconnect the TV antenna from the TV.
 - b- Connect the TV antenna cable to the ANTENNA IN jack on the rear of the VCR.
 - c- Connect the supplied RF cable between the TV OUT jack on the rear of the VCR and the TV's antenna terminal.

AV Connection

- To Connect To A TV With AV Input Terminals . . .
 - a- Connect the antenna, VCR and TV as shown in the illustration.
 - b- Connect an Audio/Video Cable between the AUDIO OUT and VIDEO OUT jacks on the rear of the VCR and the AV IN jacks on the TV.

If you have a TV with S-VIDEO input terminals, see "S-VIDEO Connection" on page 7.

4 CONNECT VCR TO POWER SOURCE

Connect the power plug to an AC outlet.

- The clock will automatically be set when the antenna is connected and when the AC is first connected to the VCR (☞ pg. 8).

5 FINAL PREPARATION FOR USE

Select the VCR channel (3 or 4) by setting the switch on the rear of the VCR as shown in the illustration.

Turn on the power to the TV. You are now able to perform simple playback (☞ pg. 23) and recording (☞ pg. 24). (If 'Auto' is displayed on the front display panel, the clock is being set automatically. Wait for the time to be displayed before powering on the VCR.)

NOTES:

- The VCR channel is the channel on the TV which will display the audio and video signals from the VCR. The VCR's CH3-CH4 switch sets the VCR channel to CH3 or CH4.
- The CH3-CH4 switch is preset to the CH3 position. Set to CH4 if CH3 is used for broadcasting in your area.
- If your TV has no AV input terminals, set the channel on the TV to correspond to the CH3-CH4 switch on the back of the VCR.

- Even if your TV has AV input terminals, you must connect it to the VCR using an RF cable in order to record one show while watching another (☞ pg. 34).
- For full identification of the VCR's rear panel, refer to the Index (REAR VIEW ☞ pg. 62).

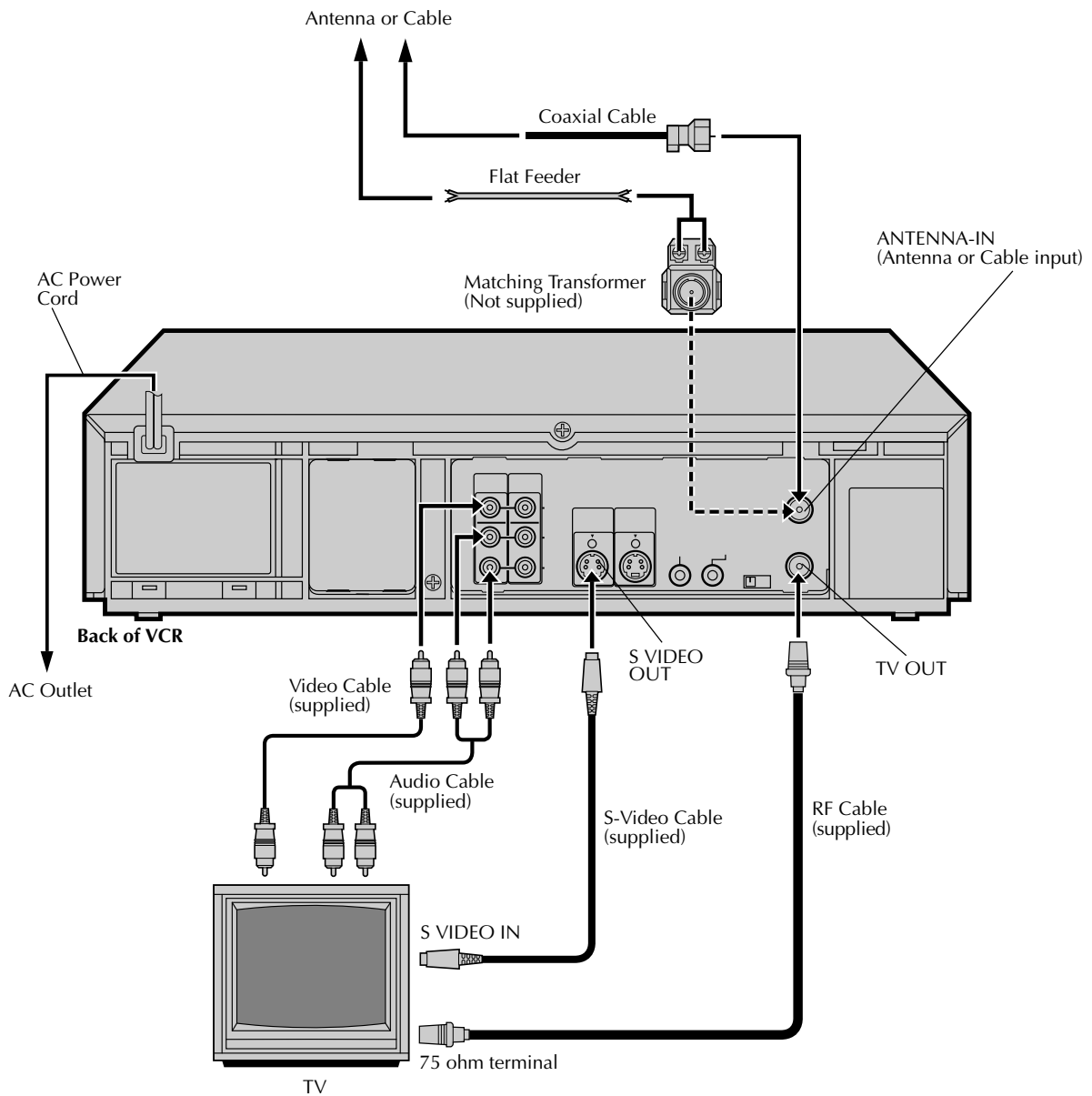

NOTES:

- To make the most of Super VHS picture performance, we recommend you use the S-VIDEO connection.
- To operate the VCR with your TV using the S VIDEO connection, set your TV to the AV mode using the TV's remote control. You can also use the **TV/VIDEO** button on the VCR's remote control to set your TV to the AV mode. (☞ pg. 53)

S-VIDEO Connection

CONNECT VCR TO TV

- Perform both RF connection and AV connection as described in step 3 of "Basic Connections" (☞ pg. 6).
- Connect the S-Video cable between the S-VIDEO OUT jack on the rear of the VCR and the S-VIDEO IN jack on the TV.



Clock

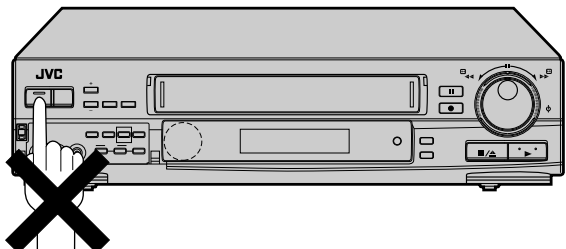

ATTENTION CABLE BOX SUBSCRIBERS

If you perform the Advanced Auto Clock Set procedure . . .

- Select the PBS channel on your cable box before plugging your VCR's power plug into the AC outlet. (If you have more than one PBS channel, you may have to select an alternative PBS channel if Advanced Auto Clock Set is not successful.)
- If there is no PBS channel in your area, perform the Manual Clock Set procedure (pg. 11).
- For automatic clock adjustment to take place the VCR's power must be off and the cable box must be set to the PBS channel at clock adjustment times.
- If you perform Advanced Auto Clock Set successfully, D.S.T. will be set to "AUTO". At the D.S.T. adjustment time (pg. 11), your VCR's power must be off and your cable box must be set to the host PBS channel in your area for the D.S.T. adjustment to take place. If the clock is not set correctly, change the D.S.T. setting to "ON" or "OFF". See step 9 of Semi-Auto procedure (pg. 10) or step 6 of Manual procedure (pg. 11).

Advanced Auto Clock Set

The time and date can be set automatically from clock setting data that is transmitted by one of the regular TV broadcast channels. We call this TV channel the "Host Channel" and it is a PBS channel in your area. With the antenna cable connected, your VCR can automatically set the clock when the power plug is first connected to an AC outlet.

The Advanced Auto Clock Set function scans all the channels received by your VCR to find the Host Channel and then sets the clock.

**Don't turn the power on until the time (or "-- : --") appears on the front display panel.*

Before the clock is set, AUTO appears on the display.

NOT SET



SET



After setting, the current time appears (in hours and minutes).

The Advanced Auto Clock Set function will normally set the clock correctly. However, if an incorrect time is displayed on the front display panel, you may be receiving the clock setting data of a PBS channel from an adjacent time zone, or an incorrect PBS channel from a cable TV system. In this case, perform the Semi-Auto (pg. 10) or Manual (pg. 11) clock setting procedure.

If "AUTO CLOCK SET" or "SEMI-AUTO CLOCK SET" is selected at the Override Auto Clock Set screen on page 10, the clock will be adjusted automatically by the Host PBS every hour on the hour (except for 11:00 PM, midnight, 1:00 AM and 2:00 AM) by the incoming PBS channel clock setting data. (This automatic clock adjustment can only be performed when the VCR's power is turned off. The clock will be adjusted on the hour based on the time displayed on the VCR, not on the actual real time.) The default setting is "AUTO CLOCK SET".

If "-- : --" appears on the display, your antenna cable may not be connected to the VCR, there may not be a Host PBS signal available in your area, or your cable box may not be set to the PBS channel. If the antenna connection or cable box setting is incorrect, connect the antenna cable to the VCR or select the correct cable channel. Then power on and power off the VCR, the Advanced Auto Clock Set mode will be automatically reactivated and "Auto" will be displayed on the VCR's front panel. If everything is connected and set correctly, perform the Manual Clock Set procedure (pg. 11).

NOTE:

If, due to a power outage or other event, the memory backup fails, Advanced Auto Clock Set is performed when power is restored to the VCR.

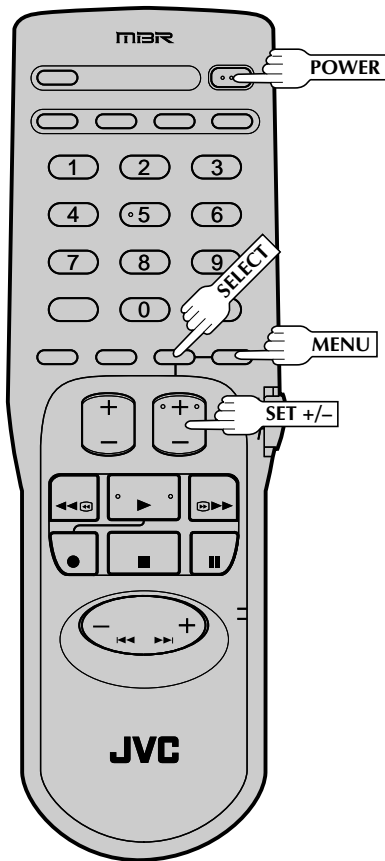
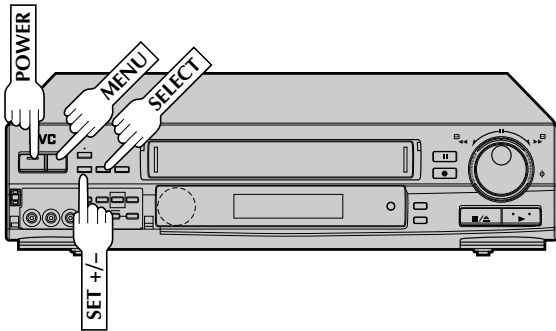

Clock Setting

Perform clock setting only if the clock has not been set correctly by Advanced Auto Clock Set. Access the Override Auto Clock Set screen to choose the Auto, Semi-Auto or Manual clock setting procedure. Each procedure starts from step 5. *Auto need only be selected if Semi-Auto or Manual had previously been selected.

Preparation

1 TURN ON THE VCR

Press **POWER**.

2 ACCESS ON-SCREEN MENU

Press **MENU** as many times as necessary to bring up the Main Menu screen.

- You can change the on-screen display language to Spanish, French, and back to English. If necessary, see "Language" on page 12.

3 ACCESS CUSTOM SET SCREEN

At the Main Menu screen, place the arrow next to "CUSTOM SET" by pressing **SET +/-**, then press **SELECT**.

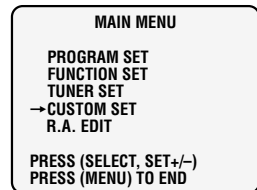

4 ACCESS CLOCK SET MODE SELECT SCREEN

Place the arrow at the Custom Set screen next to "OVERRIDE AUTO CLOCK SET" by pressing **SET +/-**. Then press **SELECT**.

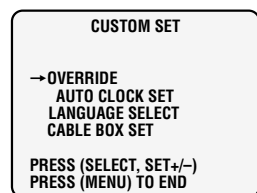

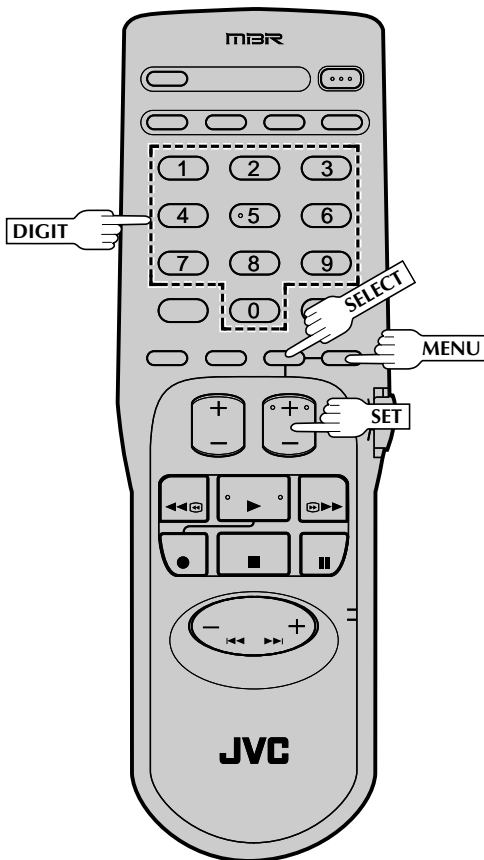
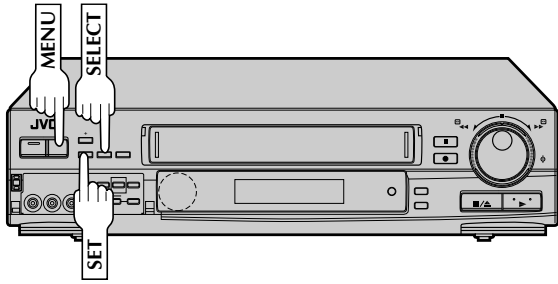

Semi-Auto

5

SELECT MODE

At the Override Auto Clock Set screen, place the arrow next to "SEMI-AUTO CLOCK SET" by pressing **SET +/-**, then press **SELECT**.

VERRIDE AUTO CLOCK SET

AUTO CLOCK SET
→ SEMI-AUTO CLOCK SET
MANUAL CLOCK SET

PRESS (SELECT, SET+/-)
PRESS (MENU) TO END

6

ACCESS SELECT SCREENS

At the Semi-Auto Clock Set screen, place the arrow next to the desired mode by pressing **SET +/-**, then press **SELECT**.

SEMI-AUTO CLOCK SET

→ HOST CHANNEL SELECT
TIME ZONE SELECT
D. S. T. SELECT

PRESS (SELECT, SET+/-)
PRESS (MENU) TO END

To select the Host Channel — step 7
To select the Time Zone — step 8
To select the D.S.T. mode — step 9

7

SELECT HOST CHANNEL

You can either select "AUTO", or enter a PBS channel number. For automatic channel selection, simply press **MENU**. To manually select the PBS channel, press the appropriate **DIGIT** key or **SET +/-** to cycle through the channel numbers (hold button down to speed through numbers) and stop when the desired number appears. Press **MENU** and the Semi-Auto Clock Set screen reappears.

HOST CHANNEL SELECT

(CATV)
CH AUTO

PRESS (SET+/-) TO SELECT
PRESS (MENU) TO END

NOTES:

- For cable box users: Select "AUTO" or the channel on your VCR that receives the cable box channels, and set the cable box to the PBS channel.
- There are some PBS channels that do not transmit clock setting data.

8

SELECT TIME ZONE

You can either select "AUTO", or select the correct zone. If you selected "AUTO" in step 7 and if you live near the boundary of an adjacent time zone, or receive cable TV channels, a PBS channel from a different time zone may become your host channel. Therefore, in this case make sure to manually select the correct time zone. Place the arrow next to your choice by pressing **SET +/-**, then press **MENU** to return to the Semi-Auto Clock Set screen.

TIME ZONE SELECT

→ AUTO MOUNTAIN
ATLANTIC PACIFIC
EASTERN ALASKA
CENTRAL HAWAII

PRESS (SET+/-) FOR CHOICE
PRESS (MENU) TO END

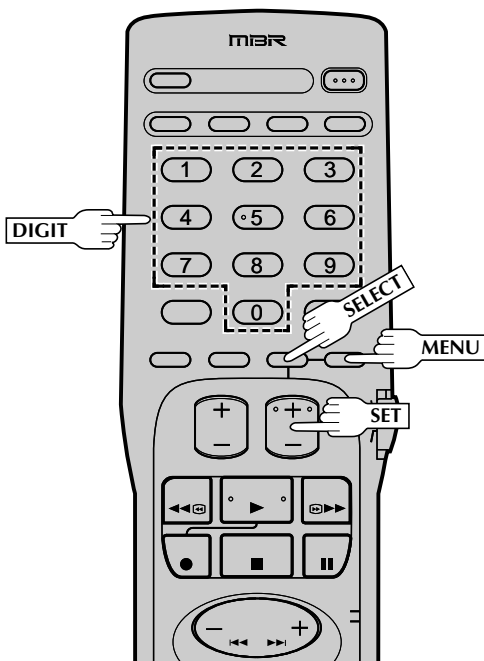
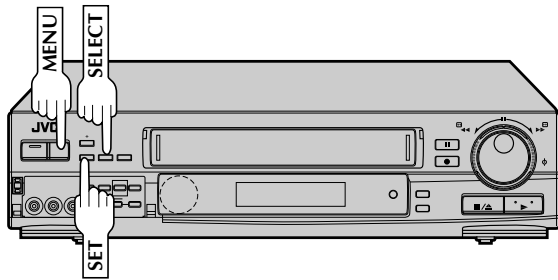
****AUTO DAYLIGHT SAVING TIME**

This function enables automatic adjustment of the VCR's clock at the start and end of Daylight Saving Time. With Auto DST activated, . . .

- . . . on the first Sunday of April at 2:00 AM, the clock is adjusted to 3:00 AM.
- . . . on the last Sunday of October at 2:00 AM, the clock is adjusted to 1:00 AM.

Auto

5

SELECT MODE

At the Override Auto Clock Set screen, place the arrow next to "AUTO CLOCK SET" by pressing **SET +/-**, then power off the VCR. Do not power it on again until the clock has been adjusted. The clock is automatically adjusted on the hour except at 11:00 PM, midnight, 1:00 AM and 2:00 AM. (The clock will be adjusted on the hour based on the time displayed on the VCR, not on the actual real time.)

9

SELECT D.S.T. MODE

You have three choices:

- a-Select "AUTO" and the adjustment to your VCR's clock will be made according to the incoming signal from the host channel.
- b-Select "ON" and the adjustment will be made based on the clock itself.
- c-Select "OFF" if Daylight Saving Time doesn't apply to you.

D.S.T. SELECT

→AUTO
ON
OFF

PRESS (SET+/-) FOR CHOICE
PRESS (MENU) TO END

Place the arrow next to your choice by pressing **SET +/-**, then press **MENU** and the Semi-Auto Clock Set screen reappears.

IMPORTANT

After setting the Semi-Auto clock set, make sure that the VCR is off before the next hour so that the clock can be adjusted. (The clock is automatically adjusted on the hour except at 11:00 PM, midnight, 1:00 AM and 2:00 AM.)

Manual

5

SELECT MODE

At the Override Auto Clock Set screen (pg. 10), place the arrow next to "MANUAL CLOCK SET" by pressing **SET +/-**, then press **SELECT**.

6

SET DATE, TIME AND D.S.T.

The Manual Clock Set screen is displayed and the first setting that can be set begins blinking. Press **SET +/-** to set the month, then press **SELECT**. The day display begins blinking. Repeat the procedure to set the day, year, hour (including AM/PM), minutes and D.S.T. (Daylight Saving Time).

MANUAL CLOCK SET

DATE 1/1/96 MON
TIME --:-- AM
D.S.T. ON

PRESS (SELECT, SET+/-)
PRESS (MENU) TO END

- As for the D.S.T. setting
 - a-Set to "ON" and the adjustment will be made based on VCR's clock.
 - b-Set to "OFF" if D.S.T. doesn't apply to you.

When you're finished with this set-up procedure, press **MENU** to start the clock.

7

MAKE CORRECTIONS

To change any of the settings, press **SELECT** until the item you want to change blinks, then set as in step 6.

Language

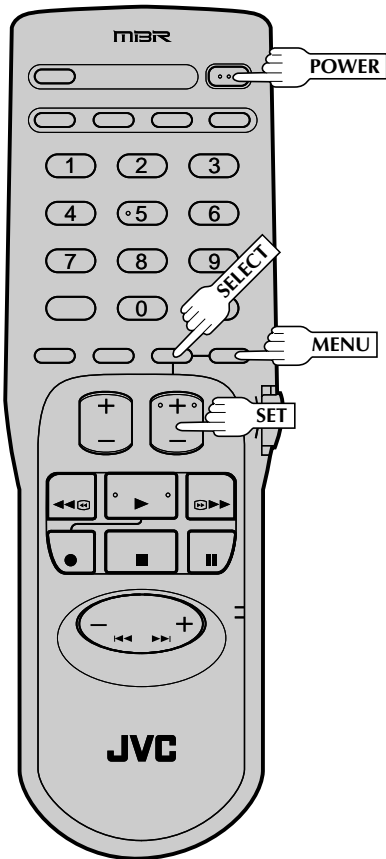
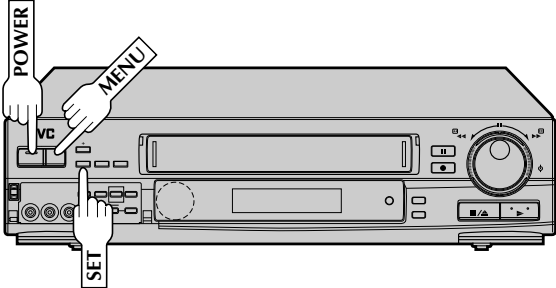

This VCR offers you the choice to view on-screen messages in English, Spanish or French (not including messages superimposed on the TV picture). Select the desired language using this procedure. The default setting is "ENGLISH".

1 TURN ON THE VCR

Press **POWER**.

2 ACCESS ON-SCREEN MENU

Press **MENU** as many times as necessary to bring up the Main Menu screen.

3 ACCESS CUSTOM SET SCREEN

At the Main Menu screen, place the arrow next to "CUSTOM SET" by pressing **SET +/-**, then press **SELECT**.

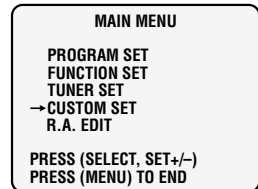

4 ACCESS LANGUAGE SELECT SCREEN

The messages are preset to appear in English. If you want to see them in Spanish or French, place the arrow next to "LANGUAGE SELECT" by pressing **SET +/-**, then press **SELECT**.

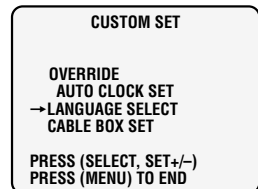

5 SELECT LANGUAGE

At the Language Select screen, place the arrow next to the desired language by pressing **SET +/-**, then press **MENU** as many times as necessary to return to the normal screen.



Tuner

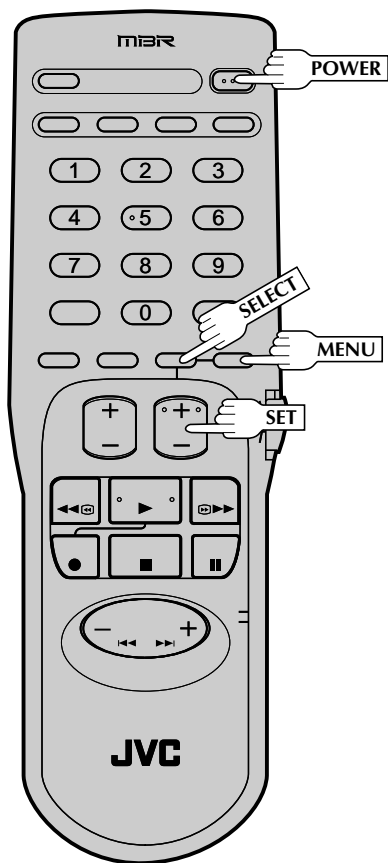
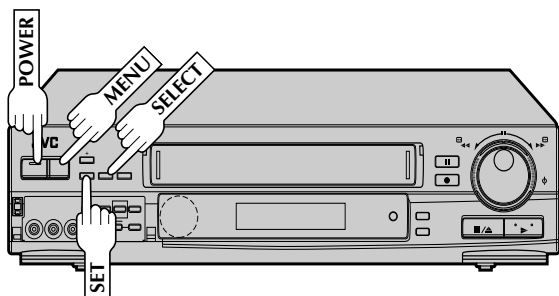

Set Receivable Channels

1

TURN ON THE VCR

Press **POWER**.

2

ACCESS MAIN MENU SCREEN

Press **MENU** as many times as necessary.

3

ACCESS TUNER SET SCREEN

Place the arrow next to "TUNER SET" by pressing **SET +/-**, then press **SELECT**.

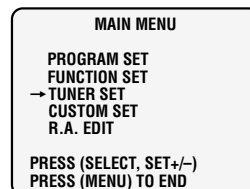

4

ACCESS BAND SCREEN

Place the arrow next to "BAND" by pressing **SET +/-**, then press **SELECT**.

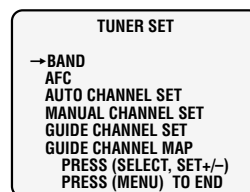

5

SET FREQUENCY BAND

If you receive your TV channels from an external antenna, select "TV". If you receive your TV channels from a cable TV system, select "CATV". Place the arrow next to your choice by pressing **SET +/-**, then press **MENU** to return to the Tuner Set screen.

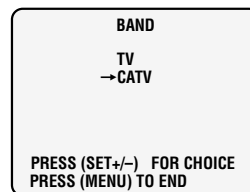

CONTINUED ON NEXT PAGE.

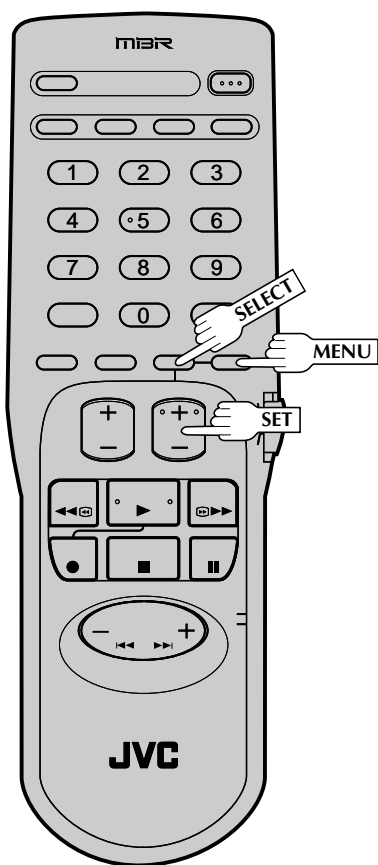
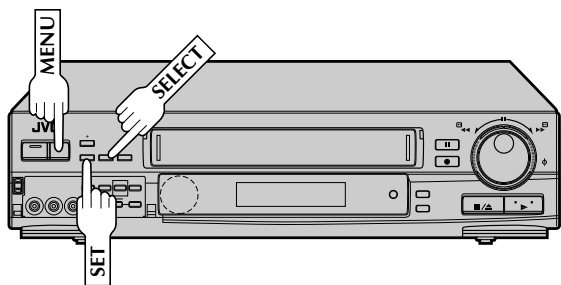

6

PERFORM AUTO CHANNEL SET

Place the arrow next to "AUTO CHANNEL SET" by pressing **SET +/-**, then press **SELECT**. Receivable channels in your area are automatically assigned to the **CH +/-** buttons, and non-receivable channels are skipped.

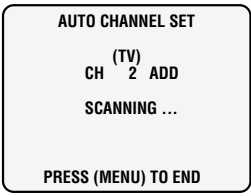

NOTES:

- At the end of Auto Channel Set, "SCAN COMPLETED" appears on screen.
- If the scan was unsuccessful, "SCAN COMPLETED-NO SIGNAL" appears on screen. Check the band setting and connections and start again.

7

RETURN TO NORMAL SCREEN

Press **MENU** as many times as necessary.

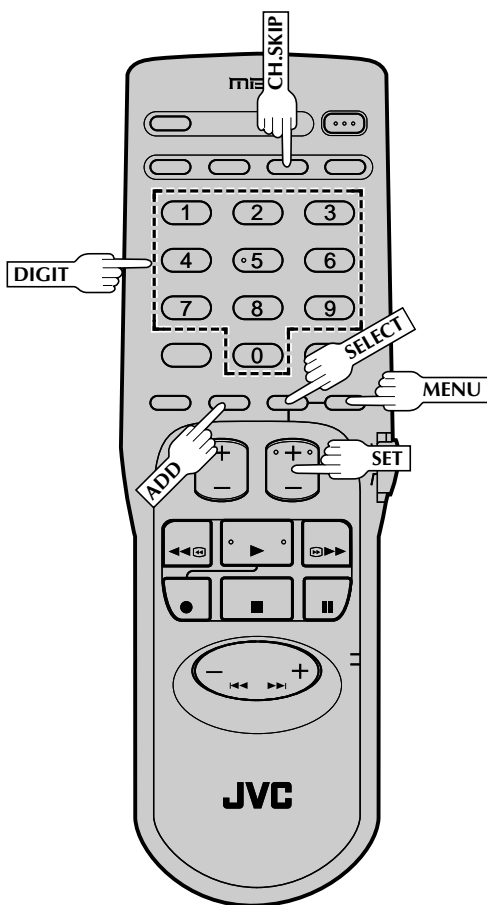
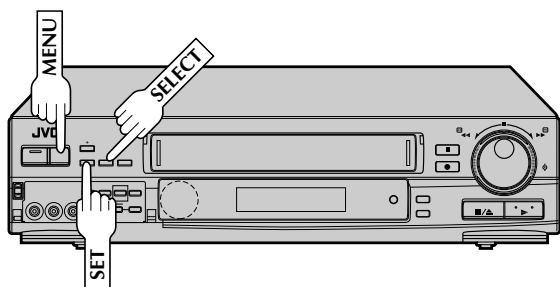

Add Or Delete A Channel

1

ACCESS TUNER SET SCREEN

Access by performing steps 2 and 3 of the Tuner procedure on page 13.

- To add a channel, go to step 2.
- To delete a channel, skip to step 4.

2

ACCESS AFC SCREEN

Place the arrow next to "AFC" by pressing **SET +/-**, then press **SELECT**.

3

MAKE SELECTION

Place the arrow next to "SPCL" by pressing **SET +/-**, then press **MENU** to return to the Tuner Set screen.

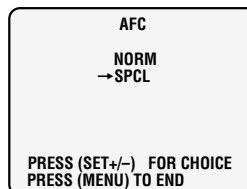

- AFC set to SPCL (special) is necessary for turning on certain CATV systems.

4

ACCESS MANUAL CHANNEL SET SCREEN

Place the arrow next to "MANUAL CHANNEL SET" by pressing **SET +/-**, then press **SELECT**.

5

STORE DESIRED CHANNEL

Input the channel number using the **DIGIT** keys or by pressing **SET +/-**, then press **ADD** to add or **CH.SKIP** to delete. Repeat for each channel you want to store or skip.

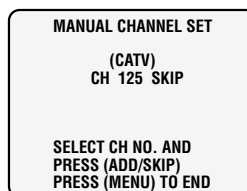

6

RETURN TO NORMAL SCREEN

Press **MENU** as many times as necessary.

Tuner And Cable Box Controller

Suggested Location

Place the cable box on top of the VCR. Attach the VCR's Cable Box Controller to the top of the VCR with the Controller's transmitter pointed towards the cable box's remote sensor.

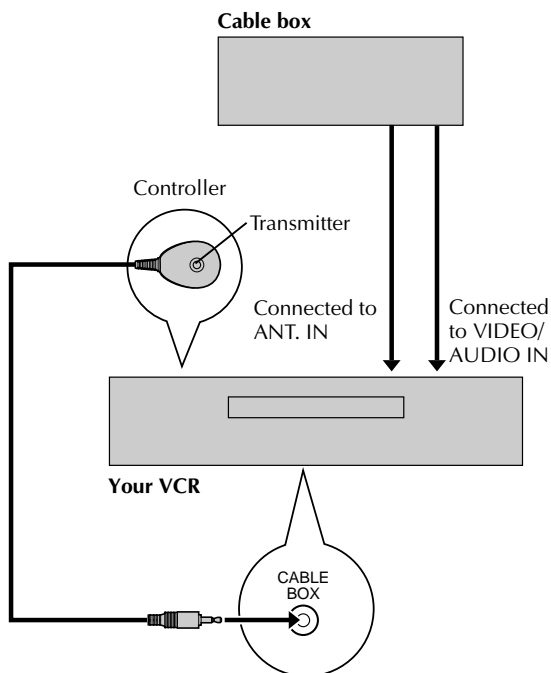
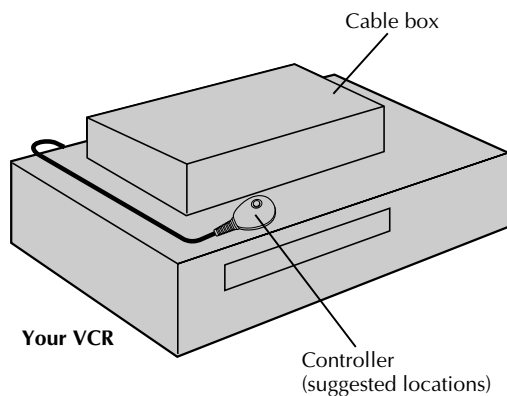

This procedure is required if you receive your TV channels through a cable box (descrambler). The Cable Box Controller allows the VCR to automatically switch the cable box channel during timer-recording. The Cable Box Controller is effective for recording shows that have been programmed using VCR Plus+ (pg. 38) or On-Screen Timer Programming (pg. 40).

Situate And Connect Controller

1 SITUATE CONTROLLER

Place the Cable Box Controller so that the path between its transmitter and the cable box's remote sensor is unobstructed.

2 ATTACH CONTROLLER

Fasten securely using the supplied adhesive strips.

3 CONNECT CABLE BOX TO VCR

The connection method depends on the type of cable box you have.

If your cable box has AUDIO and VIDEO OUT connectors . . .

. . . connect them to the AUDIO and VIDEO IN connectors on your VCR.

If your cable box doesn't have AUDIO and VIDEO OUT connectors . . .

. . . connect the antenna output connector on the cable box to the ANT.IN connector on the rear of your VCR. Set the VCR tuner to the same channel as the cable box RF output (see page 18 also).

NOTE:

Refer to your cable box's instruction manual during connection.

4 CONNECT CONTROLLER TO VCR

Connect to the CABLE BOX connector on your VCR.

About Your Cable Box

This VCR has two separate methods to control your Cable Box.

- The VCR's Wireless Remote Control Unit can control your Cable Box. This eliminates the need for a separate Cable Box Remote Control Unit.
- The VCR's Cable Box Controller can also control your Cable Box. This allows the VCR to change your Cable Box's channel number during timer recording.

Each method must be set up separately. To set up the VCR's Remote Control unit, refer to page 54. To set up the Cable Box Controller go to page 17.

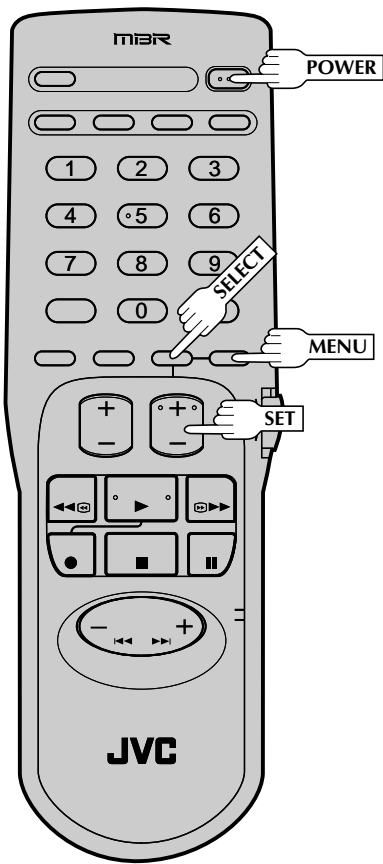
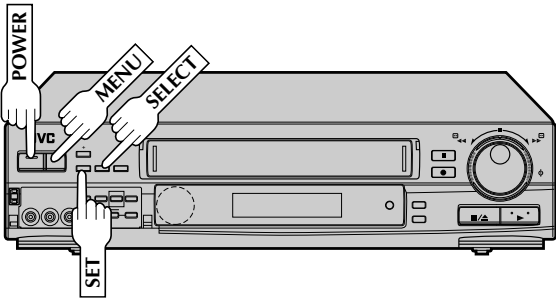

Set Cable Box Output Channel

- 1** **TURN ON THE VCR**
 Press **POWER**.

- 2** **ACCESS MAIN MENU SCREEN**
 Press **MENU** as many times as necessary.

- 3** **ACCESS CUSTOM SET SCREEN**
 Press **SET +/-** to place the arrow next to "CUSTOM SET", then press **SELECT**.

MAIN MENU

PROGRAM SET
 FUNCTION SET
 TUNER SET
 → CUSTOM SET
 R.A. EDIT

PRESS (SELECT, SET+/-)
 PRESS (MENU) TO END

- 4** **ACCESS CABLE BOX SET SCREEN**
 Press **SET +/-** to place the arrow next to "CABLE BOX SET", then press **SELECT**.

CUSTOM SET

VERRIDE
 AUTO CLOCK SET
 LANGUAGE SELECT
 → CABLE BOX SET

PRESS (SELECT, SET+/-)
 PRESS (MENU) TO END

- 5** **ACCESS CABLE BOX OUTPUT SCREEN**
 Press **SET +/-** to place the arrow next to "CABLE BOX OUTPUT", then press **SELECT**.

CABLE BOX SET

→ CABLE BOX OUTPUT
 BRAND SET

PRESS (SELECT, SET+/-)
 PRESS (MENU) TO END

CONTINUED ON NEXT PAGE.

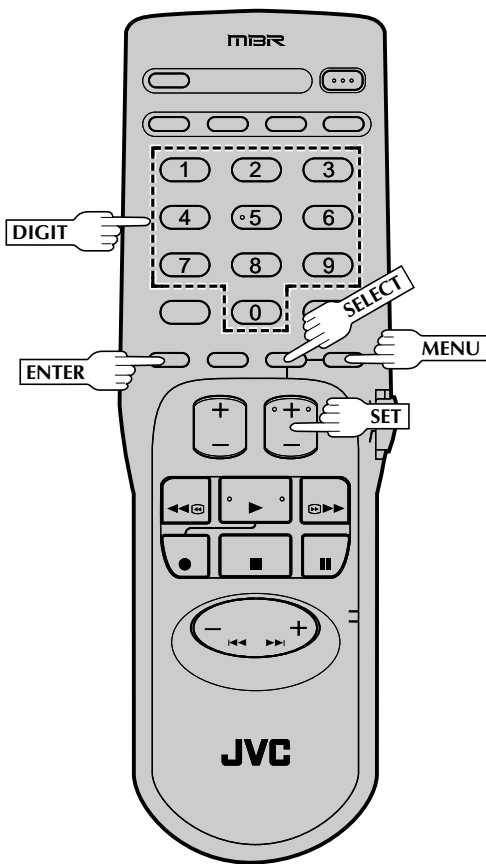
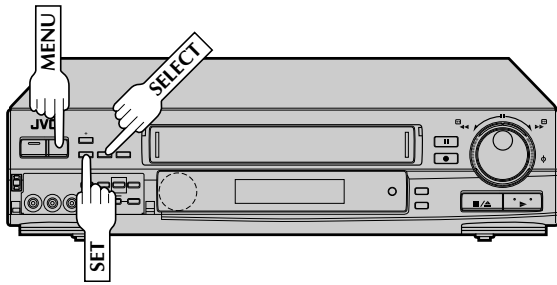

6

SELECT CABLE BOX OUTPUT CHANNEL

Your selection depends on how your cable box is connected to your VCR.

If your cable box is connected to your VCR using an RF connection . . .

. . . press SET+/- to place the arrow next to the channel number representing the cable box's output (2-6).

If your cable box is connected to your VCR's AUDIO/VIDEO IN connectors . . .

. . . press SET+/- to place the arrow next to "ON LINE".

CABLE BOX OUTPUT
→ OFF
ON CH2
ON CH3
ON CH4
ON CH5
ON CH6
ON LINE
PRESS (SET+/-) FOR CHOICE
PRESS (MENU) TO END

7

RETURN TO CABLE BOX SET SCREEN

Press MENU.

Set Cable Box Brand

1

TURN ON CABLE BOX

Select a channel other than channel 9 on your Cable Box.

2

ACCESS BRAND SET SCREEN

At the Cable Box Set screen, press SET +/- to place the arrow next to "BRAND SET", then press SELECT.

CABLE BOX SET
CABLE BOX OUTPUT
→ BRAND SET
PRESS (SELECT, SET+/-)
PRESS (MENU) TO END

3

ENTER CABLE BOX BRAND

Press the appropriate DIGIT keys to enter the Cable Box Code from the CABLE BOX BRAND LIST on page 19, then press ENTER.

CABLE BOX BRAND
1
SELECT BRAND NO. AND PRESS (ENTER)
PRESS (MENU) TO END

- If the cable box's channel changes to 9, setting is complete.
- If there are more than one code number listed for your brand of cable box, repeat step 3 until the cable box's channel changes to 9.
- If you go through all listed code numbers and the channel doesn't change, try all other numbers between 1 and 69. That is because, maybe, your cable box model is not listed.

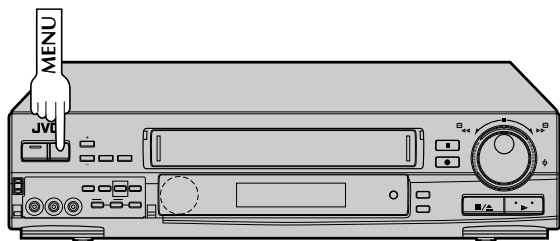

RETURN TO NORMAL SCREEN

4

Press MENU as many times as necessary.

You can now set up the VCR Plus+ feature (pg. 20).

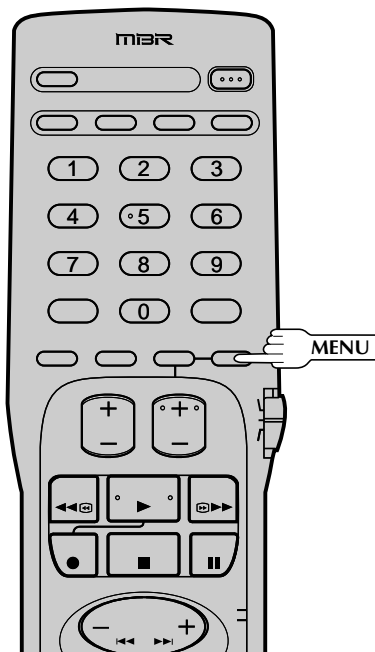

CABLE BOX BRAND LIST

BRAND	CODE
ARCHER	49, 52, 53, 54
CABLEVIEW	49, 53
CITIZEN	49, 53
CURTIS	9, 10, 62, 63
DIAMOND	52, 53, 54
EAGLE	30, 31, 32, 33, 34, 35, 36, 37
EASTERN	51
GC BRAND	49, 53
GEMINI	8, 56
GENERAL ELECTRIC	67
GENERAL INSTRUMENTS	1, 2, 3, 4, 5, 6, 7, 8
HAMLIN	15, 16, 17, 18
JERROLD	1, 2, 3, 4, 5, 6, 7, 8
MACOM, HITACHI	57, 58, 59
MAGNAVOX	30, 31, 32, 33, 34, 35, 43
MOVIE TIME	44, 45, 46
NSC	44, 45, 46
OAK	19, 20, 21, 30, 47, 48
PANASONIC	24, 25, 26
PHILIPS	30, 31, 32, 33, 42
PIONEER	13, 14
PULSER	49, 53
RCA	24, 25, 26
REGAL	15, 16, 17, 18, 33
REGENCY	51
SAMSUNG	8, 13, 49, 50
SCIENTIFIC ATLANTA	9, 10, 62, 63
SIGMA	19, 20, 21
SL MARX	8, 13, 49, 50
SPRUCER	24, 25, 26
STARGATE	8, 13, 49, 50
SYLVANIA	29
TEKNIKA	68, 69
TELECATION	27
TELEVIEW	8, 13, 49, 50
TEXSCAN	28, 29
TOCOM	22, 23, 64, 65, 66
UNIKA	52, 53, 54
UNIVERSAL	38, 39, 40, 41
VIDEOWAY	11, 12, 60, 61
VIDEO TECH	55
VIDTER	55
VIEWSTAR	30, 31, 32, 33, 34, 35, 36, 37
ZENITH	11, 12, 60, 61

NOTES:

- Although the supplied Cable Box Controller is compatible with many different cable box brands, it is possible that it will not work with your cable box.
- If your cable box doesn't respond to any code between 1 and 69, you can't use the Controller to change cable box channels. In this case, make sure to leave the cable box turned on and tuned to the proper channel before the scheduled start of timer recording. Please contact your cable company about the possibility of exchanging your current cable box with one that is compatible with your VCR.
- The VCR can only change the cable box channel through the Cable Box Controller during timer recording.
- If your cable box is one that can't be operated with a remote control (has no remote sensor), you can't use the Cable Box Controller to change its channels. Make sure to leave the cable box turned on and tuned to the proper channel before the scheduled start of timer recording.
- If you are unable to set the Cable Box Controller, please contact JVC toll free at 1-800-252-5722.



VCR Plus+ Setup

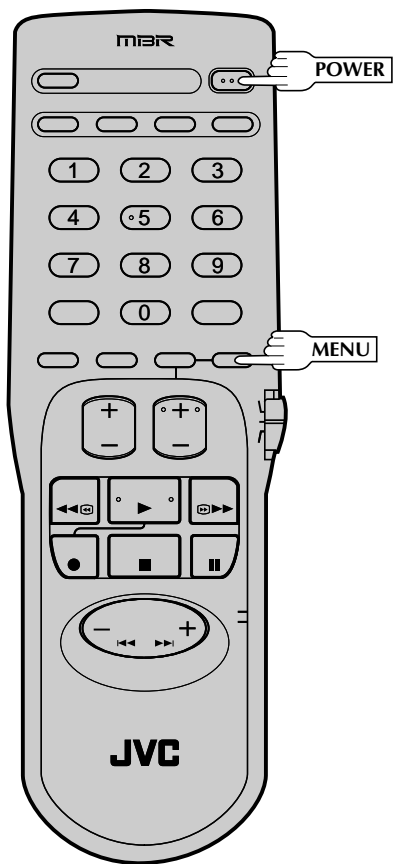
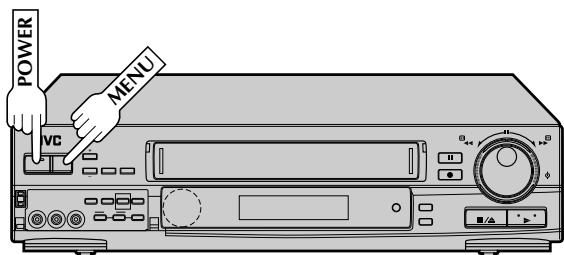

The VCR Plus+ timer programming system eliminates the need to input channel, date, start and stop time data when setting the timer record function. Simply key in the PlusCode number for the TV program you wish to record (found in most TV listings) and the VCR's timer is automatically programmed.

Depending on the TV or cable stations that you receive and the channel numbers that they are received on in your area, you may have to make certain changes in your VCR's "Guide Channel Set" menu to get proper results. Please read the following information carefully to find out which tasks you need to perform.

Before VCR Plus+ setup you must have performed the following procedures:

- Advanced Auto Clock Setting (pg. 8)

OR

- Clock setting (pg. 9)
- Tuner setting (pg. 13)
- Tuner and cable box setting if you receive your TV channels through a cable box (pg. 16)

Channel Number Matching

Most TV listings have a chart indicating the "Guide Channel" number assigned to each station for purposes of VCR Plus+ programming. Check the chart in your TV listings and see if the Guide Channel numbers listed for the stations you receive are the same as the channel number on which each is received by your VCR or cable box.

****SPECIAL NOTES FOR CABLE SUBSCRIBERS****

- In many instances, cable TV stations have VCR Plus+ Guide Channel numbers that **DO NOT** match the number of the channel on which you receive the station. Check your TV listings, or contact your cable supplier for details.
- Many normal broadcast TV stations can be viewed on cable. Check your TV listing, or contact your cable supplier for details.

If the numbers match, go directly to "VCR Plus+ Timer Programming" (pg. 38).

If the numbers are different, and you want to be able to timer record programs from those stations, you have to inform the VCR of the mismatch. Go to step 1. If you will not want to timer record from those stations, you can go directly to "VCR Plus+ Timer Programming" (pg. 38).

1 TURN ON THE VCR

Press **POWER**.

2 ACCESS MAIN MENU SCREEN

Press **MENU** as many times as necessary.

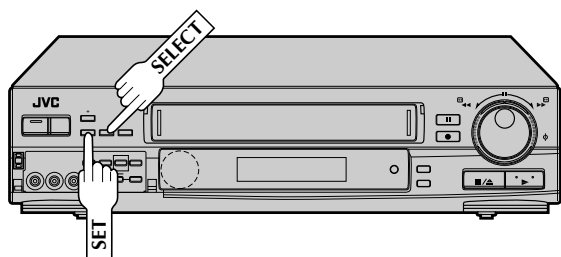

3

ACCESS TUNER SET SCREEN

Press **SET+/-** to place the arrow next to "TUNER SET", then press **SELECT**.

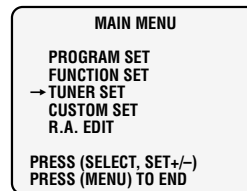

4

ACCESS GUIDE CHANNEL SET SCREEN

Press **SET+/-** to place the arrow next to "GUIDE CHANNEL SET", then press **SELECT**.

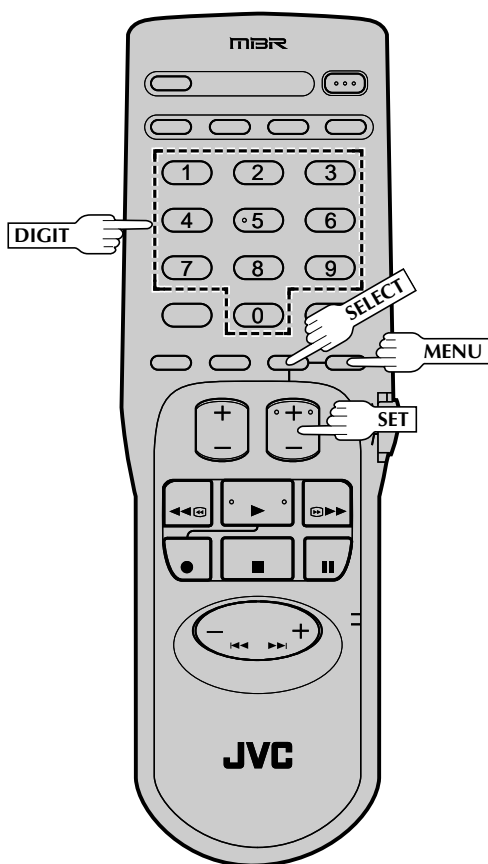
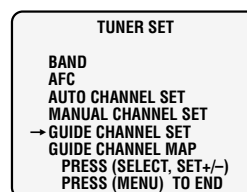

5

INPUT GUIDE CHANNEL NUMBER

Press **SET+/-** or the appropriate **DIGIT** keys to input the Guide Channel number as shown in the TV listing. Then press **SELECT**.

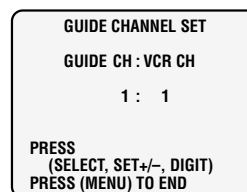

- If you receive your channels with a cable box and if you have properly set your Cable Box Controller, "CABLE CH" appears in place of "VCR CH". If not, refer to pages 16-17 and re-perform the procedure.

CONTINUED ON NEXT PAGE.

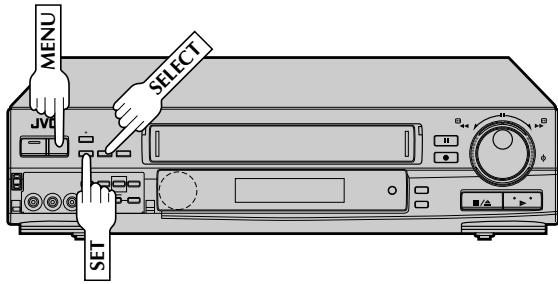

6

INPUT RECEIVING CHANNEL NUMBER

Press **SET+/-** or the appropriate **DIGIT** keys to input the number of the channel on which the Guide Channel's broadcasts are received. Then press **SELECT**.

- If there is more than one mismatch, repeat steps 5 and 6 for each instance.

7

RETURN TO TUNER SET SCREEN

Press **MENU**.

8

CHECK INPUT DATA

Press **SET+/-** to place the arrow next to "GUIDE CHANNEL MAP", then press **SELECT**.

- The Guide Channel and VCR or cable box channel numbers you input appear on the screen in ascending order. Check to ensure you've entered them correctly.
- If you entered more than 10 sets of numbers, press **SELECT** to see the next set of numbers.
- Guide Channel Map contains only the Guide Channels and VCR channels that you entered. (Guide Channels 90 through 99 may be included even if you did not enter them; this has no effect on actual operation.)

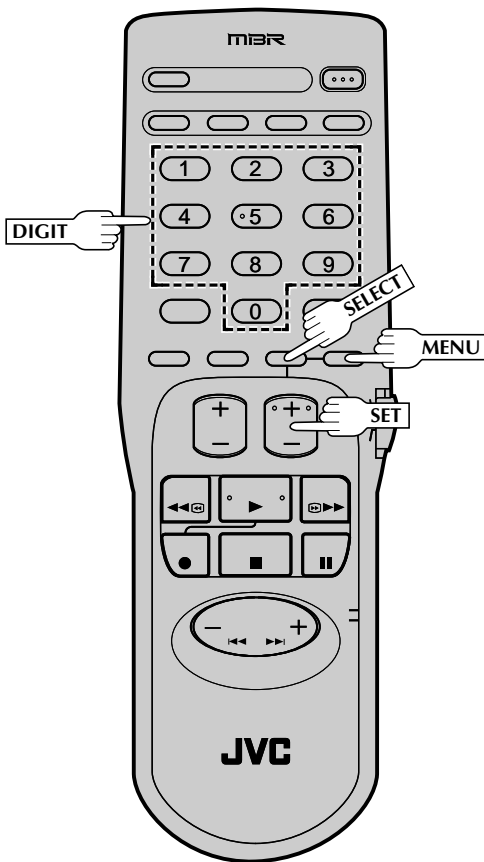
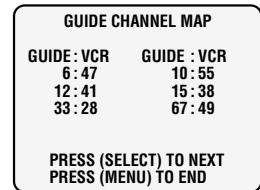
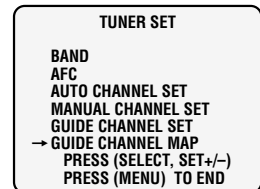

9

RETURN TO NORMAL SCREEN

Press **MENU** as many times as necessary.

You can now use VCR Plus+ for quick and simple timer programming (pg. 38).



Simple Playback

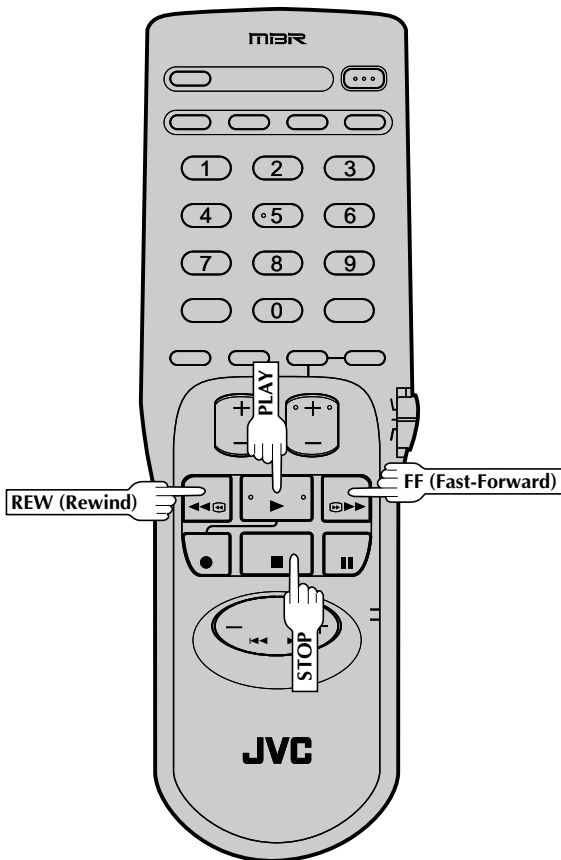
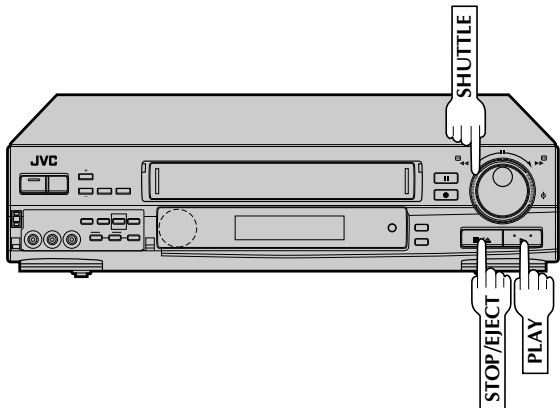

1 LOAD A CASSETTE

Make sure the window side is up, the rear label side is facing you and the arrow on the front of the cassette is pointing towards the VCR. Don't apply too much pressure when inserting.

- The VCR's power comes on automatically.
- The counter is automatically reset to "0H 00M 00S".
- If the cassette's record safety tab has been removed, playback begins automatically.

2 FIND PROGRAM START POINT

If the tape is advanced past the start point, press **REW** or turn the **SHUTTLE** ring to the left and release it. To go forward, press **FF** or turn the **SHUTTLE** ring to the right and release it.

3 START PLAYBACK

Press **PLAY**.

4 STOP PLAYBACK

Press **STOP** or **STOP/EJECT**. Then press **STOP/EJECT** to remove the cassette.

Usable cassettes

Full-Size VHS
 T-30 (ST-30**)
 T-60 (ST-60**)
 T-90
 T-120 (ST-120**)
 T-160 (ST-160**)
 ST-210**

Compact VHS*
 TC-20 (ST-C20**)
 TC-30 (ST-C30**)
 TC-40 (ST-C40**)

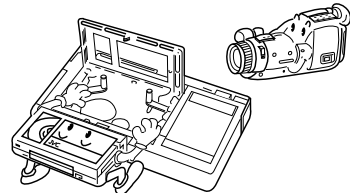

* Compact VHS camcorder recordings can be played on this video recorder. Simply place the recorded cassette into a VHS Cassette Adapter and it can be used just like any full-sized VHS cassette.

** This VCR can record on regular VHS and Super VHS cassettes. While only VHS signals can be recorded on regular VHS cassettes, both VHS and Super VHS signals can be recorded and played back using Super VHS cassettes.

Simple Recording

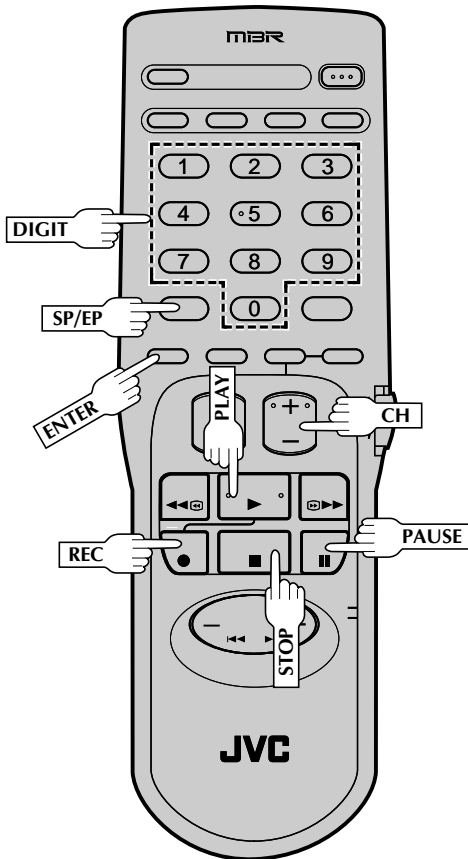
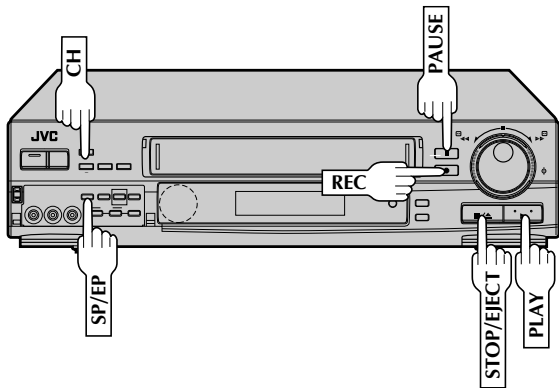

1 LOAD A CASSETTE

Make sure the record safety tab is intact. If not, cover the hole with adhesive tape before inserting the cassette.

2 SELECT RECORDING CHANNEL

Press **CH+/-**. Or press the appropriate **DIGIT** keys, then press **ENTER**. (The channel changes after a few seconds whether you press **ENTER** or not.)

3 SET TAPE SPEED

Press **SP/EP** to set the recording speed.

4 START RECORDING

Press and hold **REC** and press **PLAY** on the remote control, or press **REC** on the VCR's front panel.

5 PAUSE/RESUME RECORDING

Press **PAUSE**. Press **PLAY** to resume recording.

- During record pause, you can change the recording channel by using the **CH+/-** buttons or **DIGIT** keys.

6 STOP RECORDING

Press **STOP** or **STOP/EJECT**. Then press **STOP/EJECT** to remove the cassette.

Accidental erasure prevention

- To prevent accidental recording on a recorded cassette, remove its record safety tab. To record on it later, cover the hole with adhesive tape.

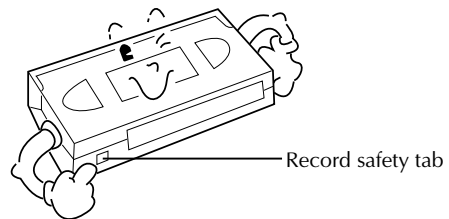



Playback

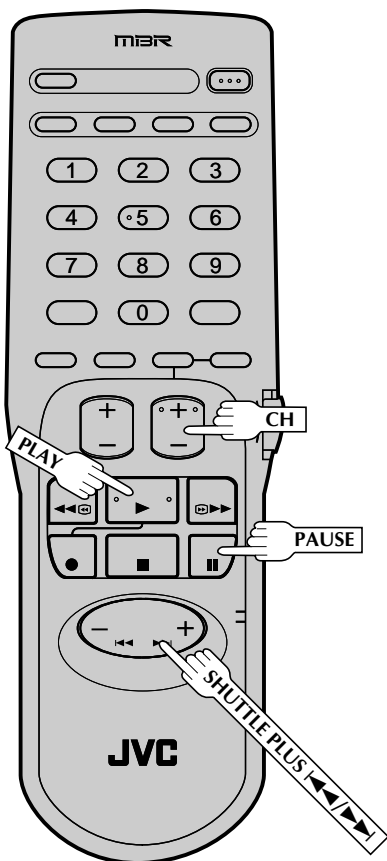
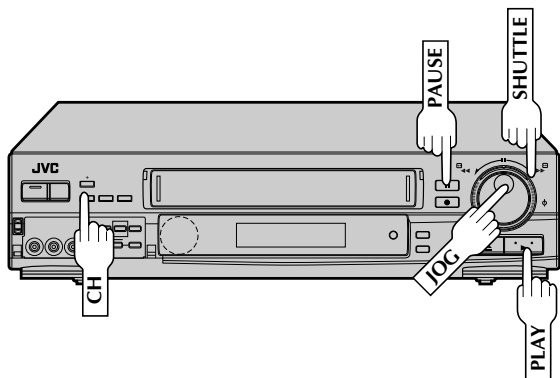

Take advantage of special functions possible with the recorder's controls or the remote control.

NOTE:

Refer to the **SHUTTLE** ring illustration as you read the following procedures.

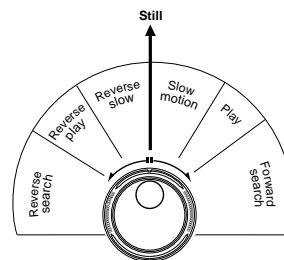

Still Picture/Frame-By-Frame Playback

- 1 PAUSE DURING PLAYBACK**
Press **PAUSE**. If there is vertical jitter, use the **CH+** or **-** button to correct the picture.
- 2 ACTIVATE FRAME-BY-FRAME PLAYBACK**
Turn the **JOG** dial to the right for forward frame-by-frame playback, or to the left for reverse frame-by-frame playback.
OR
Press **PAUSE** repeatedly to advance one frame at a time.
OR
Press **SHUTTLE PLUS** or repeatedly to advance one frame at a time.
Press **SHUTTLE PLUS** for forward frame by frame playback or **SHUTTLE PLUS** for reverse frame by frame.

To resume normal playback, press **PLAY**.

Slow Motion/Reverse Slow Motion

- 1 ACTIVATE SLOW-MOTION PLAYBACK**
During playback or still, turn the **SHUTTLE** ring to the right for forward slow motion, or to the left for reverse slow motion (refer to the illustration above).
OR
During still picture, press and hold **SHUTTLE PLUS** or . Release to return to still picture.
OR
For hands-free slow-motion, press **SHUTTLE PLUS** during playback to decrease speed in the forward direction. To play in reverse slow-motion (and in reverse play mode), continue to press after selecting all the forward direction slow-motion modes.
OR
For forward slow motion during still picture, press and hold **PAUSE** for more than 2 seconds. Press **PAUSE** again to return to still picture.

To resume normal playback, press **PLAY**.

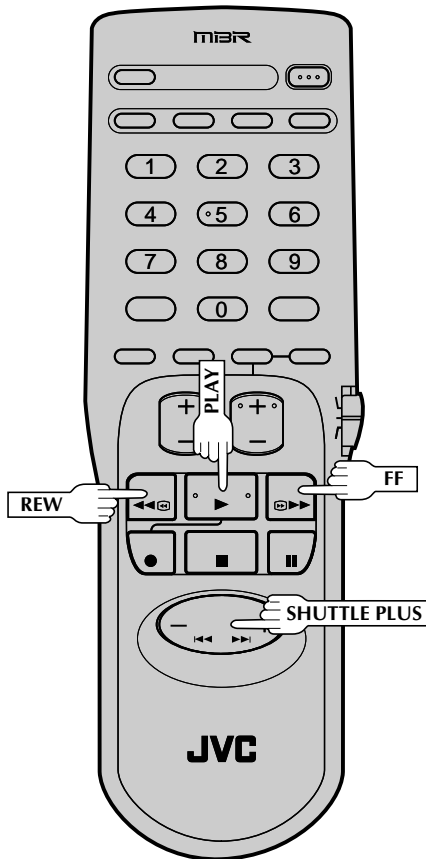
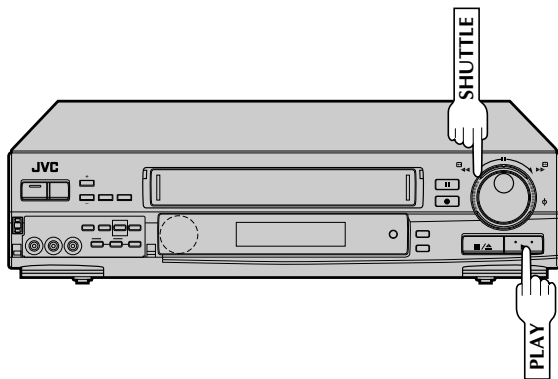

Variable-Speed Search/ Reverse Motion Playback

1 ACTIVATE VARIABLE-SPEED SEARCH

During playback or still, turn the **SHUTTLE** ring to the right for forward variable-speed search, or to the left for reverse variable-speed search (refer to the illustration on page 25).

OR

During playback, press **SHUTTLE PLUS** ◀◀ or ▶▶.

- To increase the speed in the forward direction, press ▶▶.
- To decrease the speed in the forward direction, press ◀◀.
- To play in reverse slow motion, and in reverse play mode, continue to press ◀◀ after selecting all the forward slow motion modes.

To resume normal playback, press **PLAY**.

High-Speed Search

1 ACTIVATE HIGH-SPEED SEARCH

During playback or still, turn the **SHUTTLE** ring all the way to the right for forward high-speed search, or to the left for reverse high-speed search.

- For forward search with a visible picture, during playback or still turn the **SHUTTLE** ring all the way to the right and release it within 1 second.
- For reverse search with a visible picture, during playback or still turn the **SHUTTLE** ring all the way to the left and release it within 1 second.

OR

During playback or still press **FF** for forward high-speed search, or **REW** for reverse high-speed search.

To resume normal playback, press **PLAY**.

NOTE:

For short searches, during playback or still press and hold **FF** or **REW** for over 2 seconds. When released, normal playback resumes.

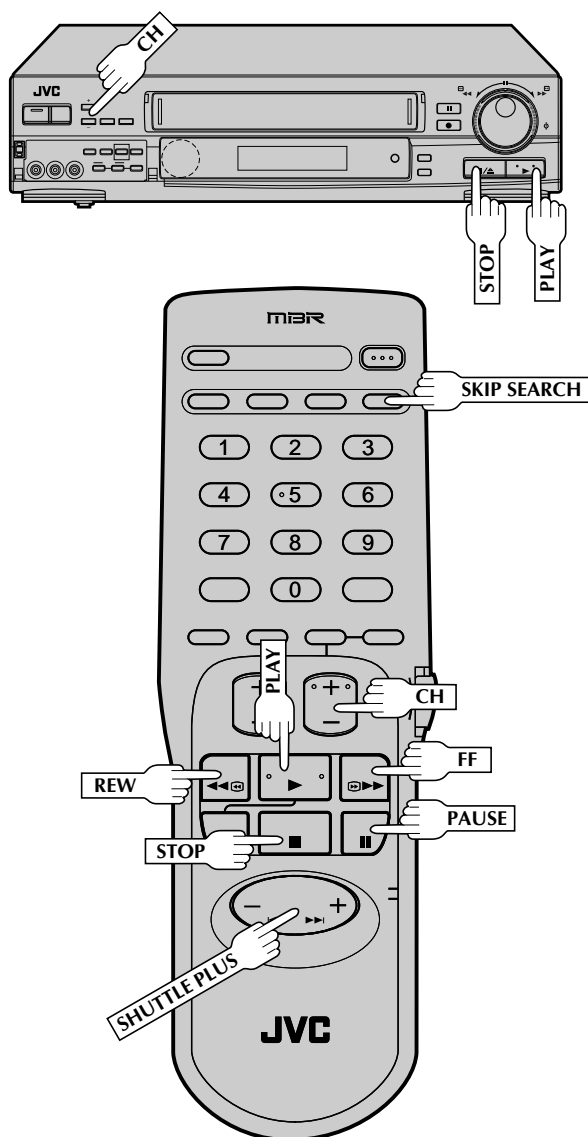

Manual Tracking

Once playback begins, the VCR's automatic tracking function is engaged. If noise appears in the picture, you can override this and make the adjustment manually.

1 ENGAGE MANUAL TRACKING MODE

During playback, press the **CH+/-** buttons on the VCR's front panel simultaneously to cancel the automatic tracking mode and enable manual tracking adjust.

2 ADJUST MANUAL TRACKING

Press **CH+/-** on the VCR's front panel or remote. Press lightly for fine adjust, or press and hold for coarse adjust. Watch the screen and continue adjusting until optimum picture and sound quality are achieved.

3 RE-ENGAGE AUTOMATIC TRACKING

Press the **CH+/-** buttons on the VCR's front panel simultaneously.

NOTES:

- To obtain a noiseless still picture it may be necessary to adjust tracking in slow playback and then engage Pause.
- Manual tracking is possible during hands-free slow-motion. During hands-free slow-motion playback simply press **CH +** or **-** on the VCR'S front panel or remote to adjust tracking.

Skip Search

1 SKIP OVER UNWANTED SECTIONS

Press **SKIP SEARCH** 1 to 4 times during playback. Each press initiates a 30-second period of fast-motion playback. Normal playback resumes automatically.

NOTE:

To return to normal playback during a Skip Search, press **PLAY**.

Repeat Playback

1 START REPEAT

Press and hold **PLAY** (until "PLAY" blinks on the front display panel) during playback, then release.



- The entire tape is played back 20 times.

2 STOP REPEAT

To stop, press **STOP** at any time.

NOTE:

Pressing **PLAY**, **REW**, **FF**, **PAUSE** or **SHUTTLE PLUS** **⏮** or **⏭** also stops Repeat Playback.

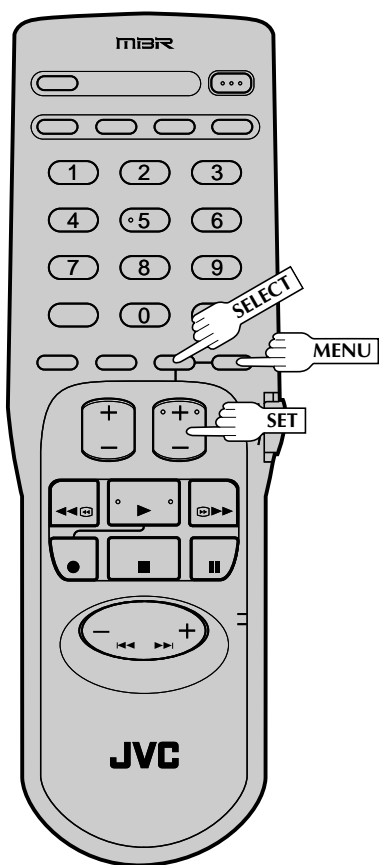
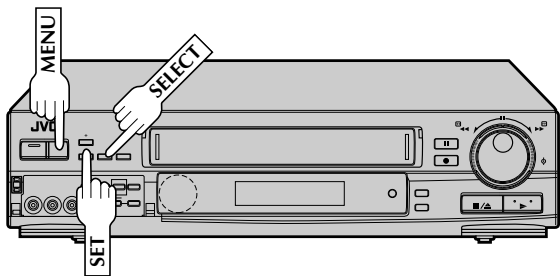

Select The Soundtrack

Your VCR can record two soundtracks simultaneously (Normal and Hi-Fi) and play back the selected one, or both together.

1

ACCESS MAIN MENU SCREEN

Press **MENU** during playback or when VCR is in stop mode.

- If the VCR Plus+ screen appears press **MENU** again.

2

ACCESS FUNCTION SET SCREEN

Place the arrow next to "FUNCTION SET" by pressing **SET+/-**, then press **SELECT**.

3

ACCESS AUDIO MONITOR SCREEN

Place the arrow next to "AUDIO MONITOR" by pressing **SET+/-**, then press **SELECT**.

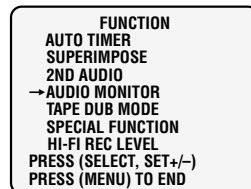

4

SELECT MODE

You have three choices:

- a- Hi-Fi
- b- Normal
- c- Mix

Place the arrow next to your choice by pressing **SET+/-**.

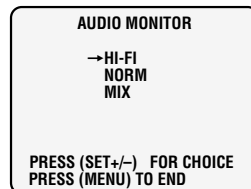

5

RETURN TO NORMAL SCREEN

Press **MENU** as many times as necessary.

NOTES:

- If the tape being played back has no Hi-Fi soundtrack, the Normal soundtrack will be heard no matter what choice you make at the Audio Monitor screen.
- If you select "HI-FI" or "MIX", the L and R symbols near the audio level meters will be illuminated.

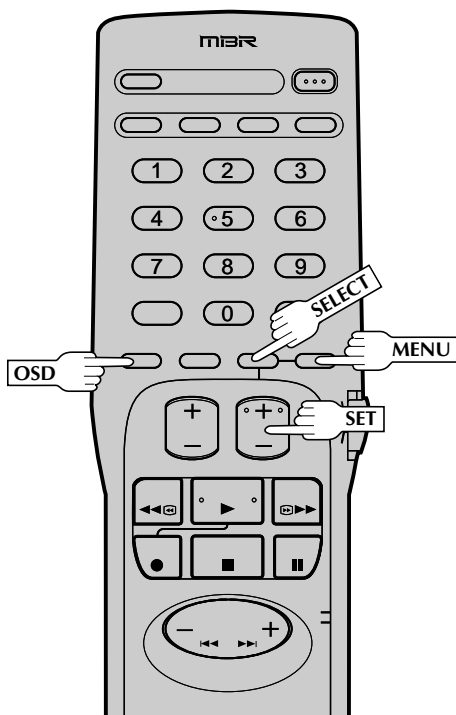
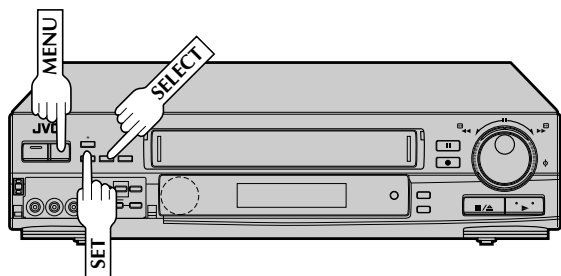

Superimpose

This function, switchable between ON and OFF, determines whether or not operational indicators will appear on screen.

1 ACCESS MAIN MENU SCREEN

Press MENU as many times as necessary.

2 ACCESS FUNCTION SET SCREEN

Place the arrow next to "FUNCTION SET" by pressing SET+/-, then press SELECT.

3 ACCESS SUPERIMPOSE SCREEN

Place the arrow next to "SUPERIMPOSE" by pressing SET+/-, then press SELECT.

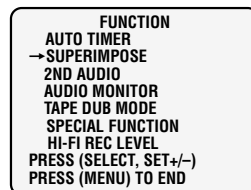

4 SELECT MODE

Place the arrow next to "ON" or "OFF" by pressing SET+/-.

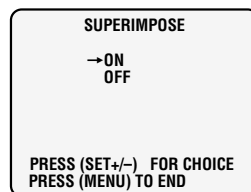

5 RETURN TO NORMAL SCREEN

Press MENU as many times as necessary.

To recall an indication

- 1 Press OSD.
 - All indications corresponding to the current status are displayed for 5 seconds, leaving the counter information, and RECORD/PAUSE if in the Record Pause mode, on the screen. (No indication during still and search.)
- 2 Press OSD again to clear the display.

NOTE:

If you engage the Record Pause mode, RECORD/PAUSE is displayed whether "SUPERIMPOSE" is set to "ON" or "OFF".

The superimposed indication on the TV screen tells you what the VCR is doing.

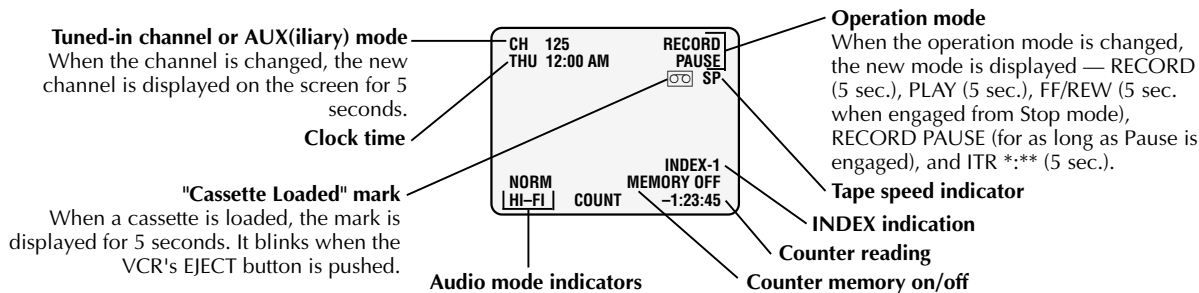

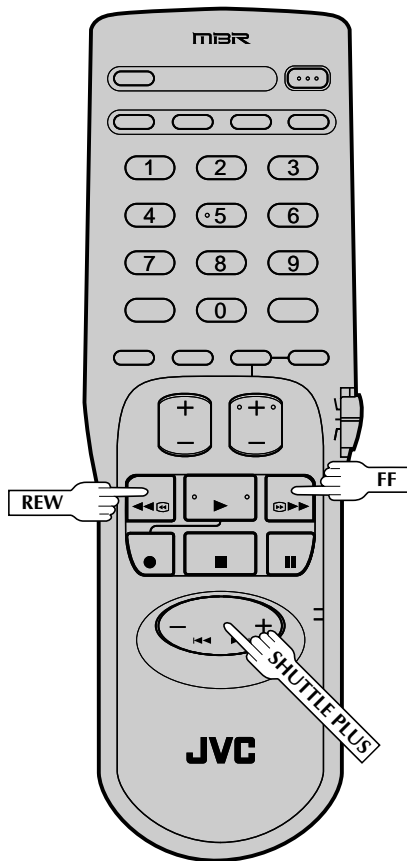
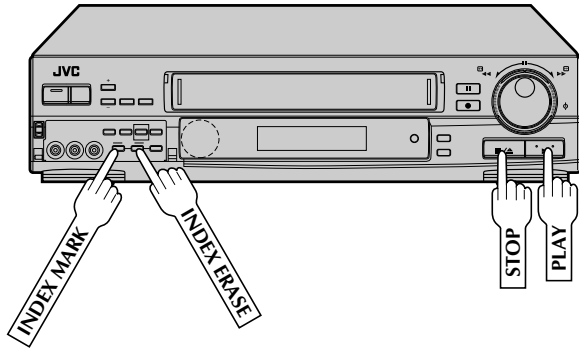

Index Search

This function seeks out index codes that are placed on the tape at recording start.

1 START SEARCH

While the tape is stopped, press **SHUTTLE PLUS** or .

2 ACCESS DISTANT CODE

To access a recording 2–9 index codes away, press **SHUTTLE PLUS** or repeatedly until the correct number is displayed on screen (only if **SUPERIMPOSE** is set to ON (pg. 29)). Playback begins automatically when the desired recording is located.

- To find the very beginning of the desired program, press **REW** or **FF** and search visually for the start point.

NOTE:

An index code is not placed on the tape when recording is paused and then resumed.

Manual Index Mark/Erase

To mark an index code...

...during playback press **INDEX MARK** on the VCR.

- The VCR will mark an index code at that location.
- If "SUPERIMPOSE" is set to ON (pg. 29), "MARK" blinks on the screen while an index code is being marked.

To erase an index code...

...during playback or still press **INDEX ERASE** on the VCR.

- The VCR will fast-forward to the nearest index code and erase it. Playback continues after the index code is erased.
- If "SUPERIMPOSE" is set to ON (pg. 29), "ERASE" blinks on the screen while an index code is being erased.

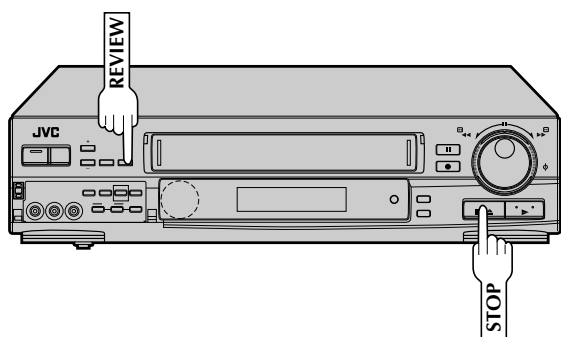

Instant ReView

At the press of a button, you can power up your VCR, rewind the tape and begin viewing the most recent timer-recorded program.

1

ACTIVATE INSTANT REVIEW

After ensuring that the VCR is off and the Timer mode is disengaged, press **REVIEW**.

- The power comes on and the VCR searches for the index code indicating the start of the last timer-recorded program, then begins playback automatically.
- You can access a program 2–9 index codes away from the current position on the tape. If, for example, you have 5 programs recorded and you want to watch the third one, press **REVIEW** three times.
- The VCR's REVIEW button lights when timer-recording is finished, and blinks while the tape is being rewound.
- To find the very beginning of the desired program, press **REW** or **FF** and search visually for the program's start point.

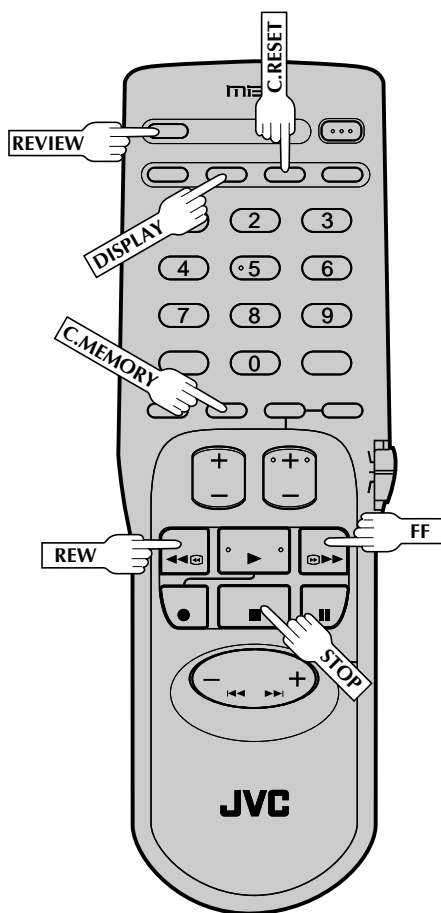

Counter Reset

1

RESET COUNTER TO ZERO

Press **C.RESET**.

NOTE:

By pressing the **DISPLAY** button, you can change the display to show the counter reading, channel number, clock time or tape remaining time. (Channel number is not displayed during playback.)

Counter Memory

When activated, this feature returns the tape to counter position "zero".

1

ACTIVATE COUNTER MEMORY

Press **C.RESET** during playback at a point you want to have quick access to later. The counter reads "0H 00M 00S".

Then press **C.MEMORY**. The Counter Memory indicator in the front display panel lights.

2

RETURN TO COUNTER POSITION ZERO

Press **STOP** (during playback), then press **REW** or **FF**. The tape rewinds or fast-forwards and stops at approximately "0H 00M 00S" automatically.

- To cancel Counter Memory, press **C.MEMORY**.

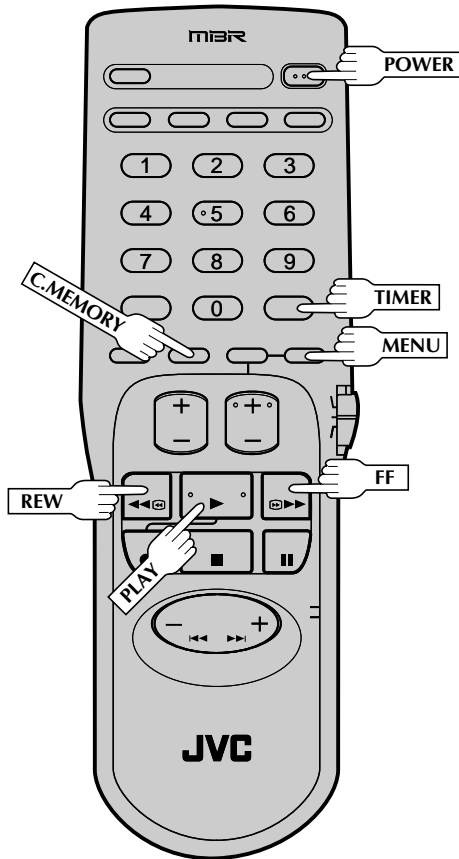
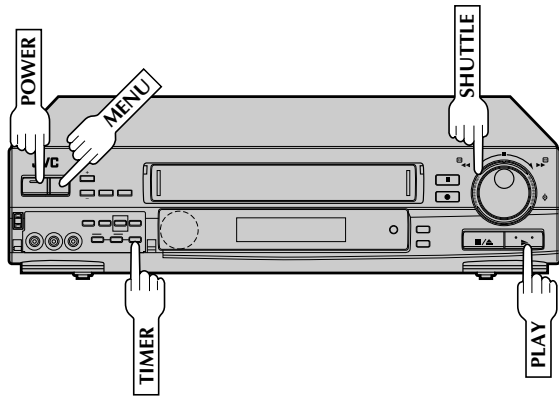

Next-Function Memory

The Next Function Memory "tells" the VCR what to do after rewinding. * Before continuing, ensure that the VCR is in stop mode.

- a- For Automatic Start Of Playback After Tape Rewind . . .
... press **REW**, then press **PLAY** within 2 seconds.
- b- For Automatic Power Off After Tape Rewind . . .
... press **REW**, then press **POWER** within 2 seconds.
- c- For Automatic Timer Standby After Tape Rewind . . .
... press **REW**, then press **TIMER** within 2 seconds.

NOTES:

- To do the above using the VCR's controls:
During Stop, turn the **SHUTTLE** all the way to the left and release it instead of pressing **REW**, and then press **PLAY**, **POWER** or **TIMER** within 2 seconds.
- If you want the "next function" to automatically start when the counter reads "0H 00M 00S" (instead of at the beginning of the tape), press **C. MEMORY** so that the counter memory indicator appears on the front display panel before pressing **REW** or **FF**.

AV COMPU LINK Playback

Your VCR is compatible with JVC's AV COMPU LINK components, including amplifiers (or receivers) and televisions. AV COMPU LINK provides one touch control of the audio and video components that are linked via their AV COMPU LINK connectors.

For example: simply load a cassette in the VCR and press **PLAY** and the AV COMPU LINK components automatically power on, the TV's VIDEO mode is selected and the VCR goes into play mode. (PLAY need not be pressed if the cassette's record safety tab is removed.)

1 MAKE CONNECTION

Connect your VCR to an AV COMPU LINK component as shown in the illustration on page 33.

- The mini-plug cable is a mono 3.5 mm mini-plug to mono 3.5 mm mini-plug connector.

2 TURN ON THE VCR

Press **POWER**.

3 ACCESS MAIN MENU SCREEN

Press **MENU** as many times as necessary.

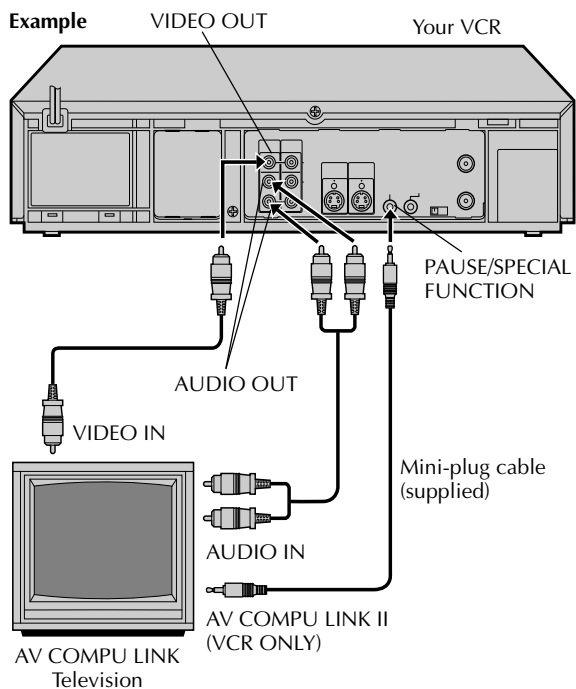
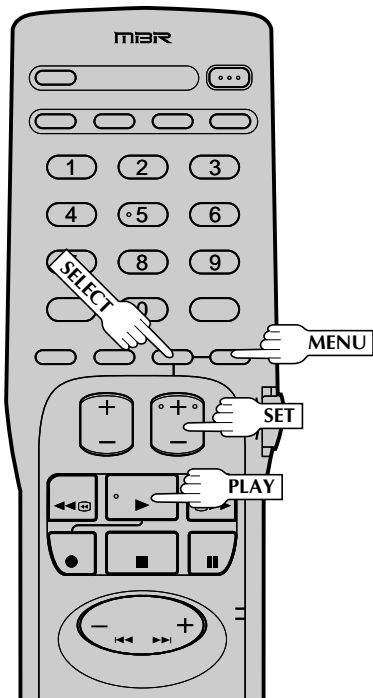
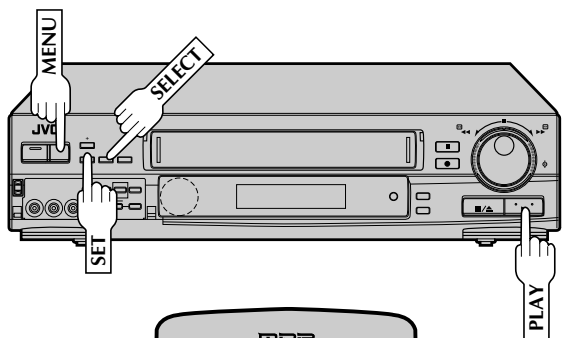

4

ACCESS FUNCTION SET SCREEN

Press **SET**+/- to place the arrow next to "FUNCTION SET", then press **SELECT**.

5

ACCESS SPECIAL FUNCTION SCREEN

Press **SET**+/- to place the arrow next to "SPECIAL FUNCTION", then press **SELECT**.

- | FUNCTION | |
|------------------------|--|
| AUTO TIMER | |
| SUPERIMPOSE | |
| 2ND AUDIO | |
| AUDIO MONITOR | |
| TAPE DUB MODE | |
| → SPECIAL FUNCTION | |
| HI-FI REC LEVEL | |
| PRESS (SELECT, SET+/-) | |
| PRESS (MENU) TO END | |

6

ENABLE AV COMPU LINK PLAYBACK

Press **SET**+/- to place the arrow next to "AV COMPU LINK".

- | SPECIAL FUNCTION | |
|---------------------------|--|
| R.A. EDIT/PAUSE | |
| → AV COMPU-LINK | |
| PRESS (SET+/-) FOR CHOICE | |
| PRESS (MENU) TO END | |

7

RETURN TO NORMAL SCREEN

Press **MENU** as many times as necessary.

8

PERFORM AV COMPU LINK PLAYBACK

Simply insert a cassette and press **PLAY** (if the cassette's record safety tab has been removed, playback begins automatically). Linked components are turned on, and the TV set to its VIDEO mode, automatically!

NOTE:

Connection varies depending on the type of JVC TV you have. Please refer to the TV's instruction manual when making this connection.

Recording

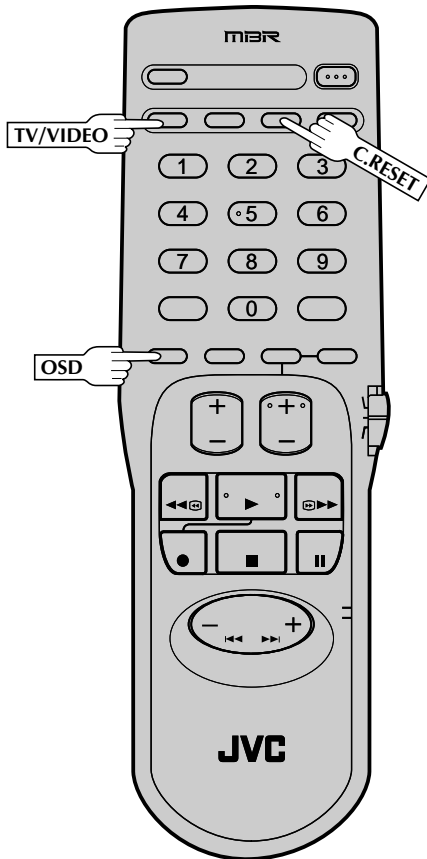
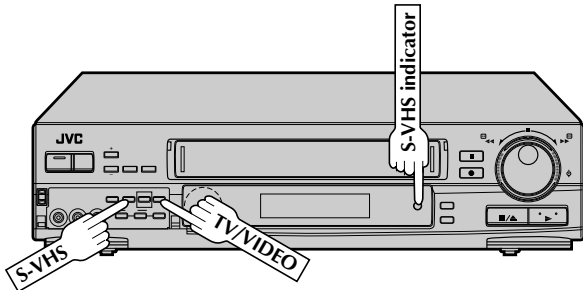

Record One Program While Watching Another

1 ENGAGE TV MODE

During recording...

- Press **TV/VIDEO**. The VCR's VIDEO indicator goes out. (If you are using the RF connection (pg. 6), to view the output from your VCR, the TV broadcast being recorded disappears.)
- If you are using the AV connection (pg. 6) or S-VIDEO connection (pg. 7), to view the output from your VCR, change the TV's input mode from AV to TV.

2 SELECT CHANNEL FOR VIEWING

Use the TV's channel selector to set the channel you want to watch.

Display Elapsed Recording Time

1 RESET COUNTER TO ZERO

Before recording starts, press **C.RESET**. The counter resets to zero and displays the exact elapsed time as the tape runs.

2 DISPLAY ELAPSED TIME ON SCREEN

During recording, press **OSD** at any time to see the elapsed time. All indications corresponding to the current status of the VCR are displayed for 5 seconds. The counter display remains on the screen indicating the elapsed time. Press **OSD** again to remove the display.

- Make sure "SUPERIMPOSE" is set to "ON" (pg. 29).
- The indications are not be recorded.

S-VHS (Super VHS) and VHS

Your VCR can record in either S-VHS or VHS.

- To record in S-VHS, insert a cassette marked "S-VHS". The S-VHS indicator will light and the S-VHS recording mode is automatically selected.
- To record in VHS, insert a cassette marked "VHS". The VHS recording mode is automatically selected.
- You can also record in VHS on S-VHS cassettes. To do this, after inserting an S-VHS cassette, press the **S-VHS** button. The S-VHS indicator will go out.

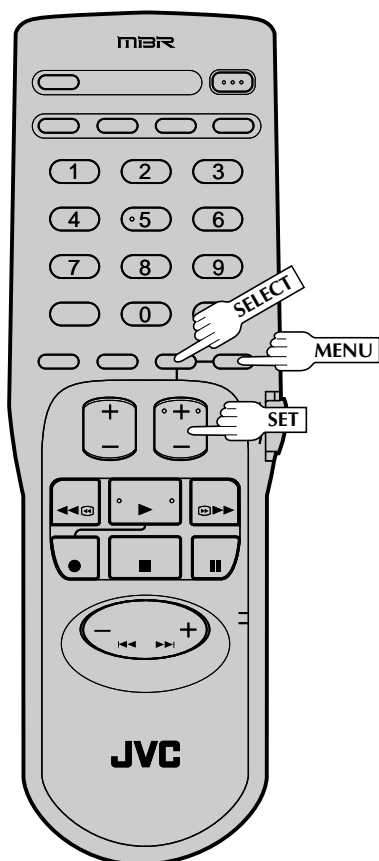
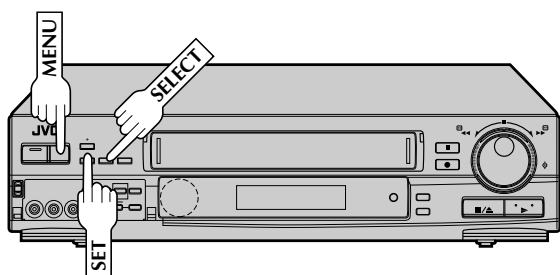

Stereo And SAP (Second Audio Program)

Your VCR's built-in MTS decoder enables reception of Multi-channel TV Sound broadcasts.

- The ST indicator on the front display panel lights during stereo broadcast reception, and SAP lights during SAP program reception.
- Both indicators light when a stereo program is accompanied by SAP audio.

To Record Stereo Programs . . .

. . . simply follow the basic recording procedure.

To Listen To Stereo Soundtrack During Recording . . .

. . . select "HI-FI" at the Audio Monitor screen (☞ pg. 28).

To Record SAP Programs . . .

ACCESS MAIN MENU SCREEN

1 Press **MENU** as many times as necessary.

ACCESS FUNCTION SET SCREEN

2 Place the arrow next to "FUNCTION SET" by pressing **SET+/-**, then press **SELECT**.

ACCESS 2ND AUDIO SCREEN

3 Place the arrow next to "2ND AUDIO" by pressing **SET+/-**, then press **SELECT**.

SELECT MODE

4 Place the arrow next to "ON" by pressing **SET+/-**.

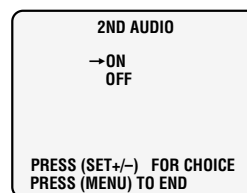

RETURN TO NORMAL SCREEN

5 Press **MENU** as many times as necessary.

NOTES:

- If a SAP program is received, the SAP audio is recorded on both the Normal and Hi-Fi tracks. The main audio program is not recorded.
- If a non-SAP program is received, the main audio is recorded on both the Hi-Fi and Normal audio tracks.

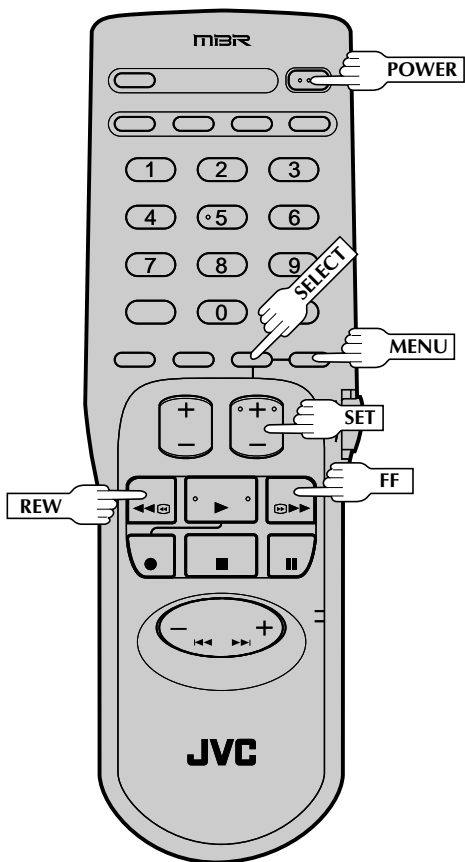
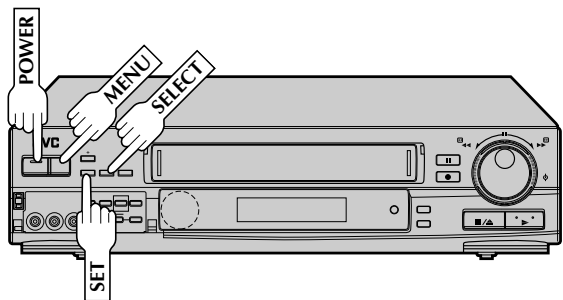

Hi-Fi Audio Recording Level Control

Your VCR allows manual adjustment of the Hi-Fi audio recording level. Although the preset audio recording level is satisfactory for normal recording, if the sound you are going to record is too loud or too low, adjust the audio recording level while referring to the VCR's audio level meters.

- 1** **TURN ON THE VCR**
 Press **POWER**.

- 2** **ACCESS MAIN MENU SCREEN**
 Press **MENU** as many times as necessary.

- 3** **ACCESS FUNCTION SET SCREEN**
 Press **SET +/-** to place the arrow next to "FUNCTION SET", then press **SELECT**.

- 4** **ACCESS HI-FI REC LEVEL SCREEN**
 Press **SET +/-** to place the arrow next to "HI-FI REC LEVEL", then press **SELECT**.

FUNCTION

AUTO TIMER
SUPERIMPOSE
2ND AUDIO
AUDIO MONITOR
TAPE DUB MODE
SPECIAL FUNCTION
→ HI-FI REC LEVEL
PRESS (SELECT, SET+/-)
PRESS (MENU) TO END

- 5** **SELECT MODE**
 Place the arrow next to "MANUAL" by pressing **SET +/-**.

HI-FI REC LEVEL CONTROL

PRESET
→ MANUAL

PRESS (REW) PRESS (FF)
MIN-----MAX

PRESS (SET+/-) FOR CHOICE
PRESS (MENU) TO END

- 6** **ADJUST AUDIO RECORDING LEVEL**
 Press **FF** or **REW**.
 - To move the on-screen's audio levels by one division of the scale, press **FF** or **REW** briefly for 5 times in succession. To move the audio levels faster, keep **FF** or **REW** pressed.
 - Adjust the recording level so that the audio level meters reach from 0dB to 4dB at the maximum sound volume.

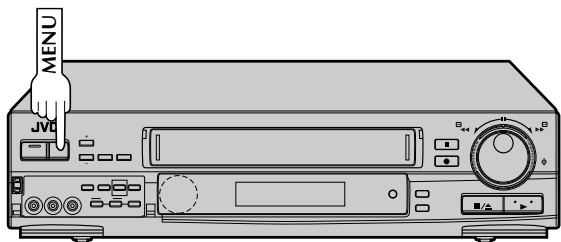

RETURN TO NORMAL SCREEN

7

Press **MENU** as many times as necessary to exit.

NOTE:

- Noise will increase if the recording level is too low, while distortion will increase if the level is too high.

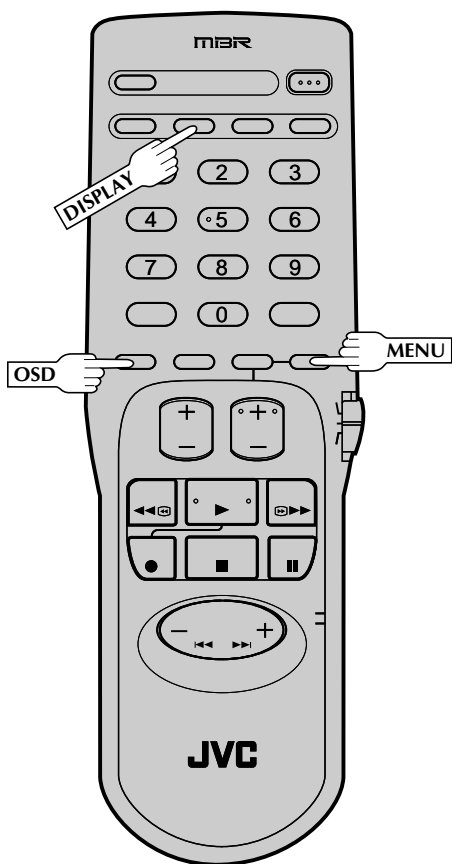

Display Tape Remaining Time

DISPLAY COUNTER INFORMATION

1

Press **OSD**.

DISPLAY TAPE REMAINING TIME

2

Press **DISPLAY** until "REMAIN" appears on screen. The approximate tape remaining time appears on the TV screen and VCR display panel.

- The tape remaining time is calculated based on the tape speed (SP or EP) being used. The indicated remaining time is only an estimate.
- By pressing **DISPLAY**, you can change the indication on the display panel to show the counter reading, channel number, clock time or tape remaining time.

EXIT THE DISPLAY

3

Press **OSD** again.

NOTES:

- "SUPERIMPOSE" must be set to "ON", or the on-screen display will not appear (see pg. 29).
- Near the beginning of the tape, this estimate may be inaccurate. However, as the tape is used and the amount of remaining tape decreases, the estimate becomes more accurate.
- The tape remaining time indication is not accurate when using VHS-C tapes with VHS-C adapter.

VCR Plus+ Timer Programming

Before VCR Plus+ Timer programming, see "VCR Plus+ Setup" on page 20.

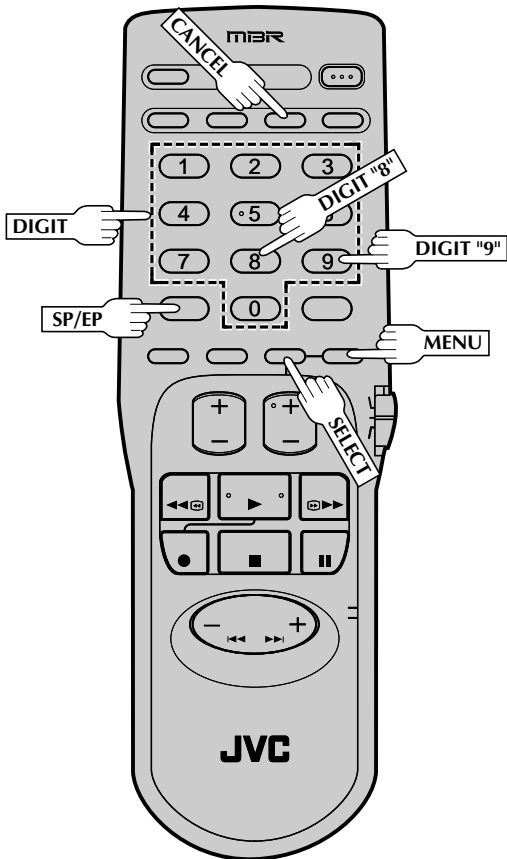
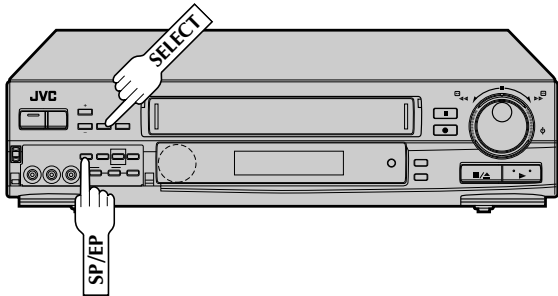

Timer recording allows you to program the VCR to automatically record a program which will be broadcast at some future time. The timer record function can be programmed using VCR Plus+ or On-Screen Timer Programming (pg. 40).

1 LOAD A CASSETTE

Make sure the record safety tab is present.

- The VCR's power comes on automatically.

2 ACCESS VCR PLUS+ SCREEN

Press **MENU** on the remote control.

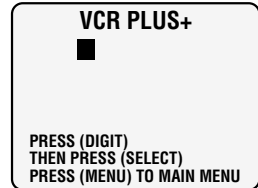

- The clock must be set in order to access the VCR Plus+ screen. If you haven't set the clock, the Main Menu screen appears when you press **MENU**. Refer to page 8 for the Advanced Auto Clock Set procedure or page 9 for the clock setting procedure.

3 ENTER PLUSCODE NUMBER

Press the appropriate **DIGIT** keys to enter the PlusCode number printed in the TV listings for the TV program you wish to record.

- To make corrections, press **CANCEL** and input the correct PlusCode number.
- If the PlusCode number you input is incorrect, "ERROR" may appear on the screen to advise you of the error. This happens when the PlusCode number is for a program which has already passed. "ERROR" is displayed for about 4 seconds and the VCR Plus+ screen reappears (step 2).

4 CHECK INPUT DATA

Press **SELECT** and the Program screen appears. The PlusCode number you entered appears in the Program screen. Check to make sure it's accurate.

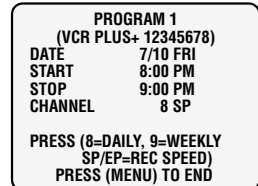

- To timer-record daily or weekly serials, press **DAILY** (**DIGIT "8"**) or **WEEKLY** (**DIGIT "9"**). "DAILY" or "WEEKLY" appears on the Program screen.
- For weekly recording, the desired date for the day of the week must be entered.
- If you made a mistake, press **CANCEL** and, after pressing **MENU** as many times as necessary to access the VCR Plus+ screen, input the correct PlusCode number.

5 SET TAPE SPEED

Press **SP/EP**.

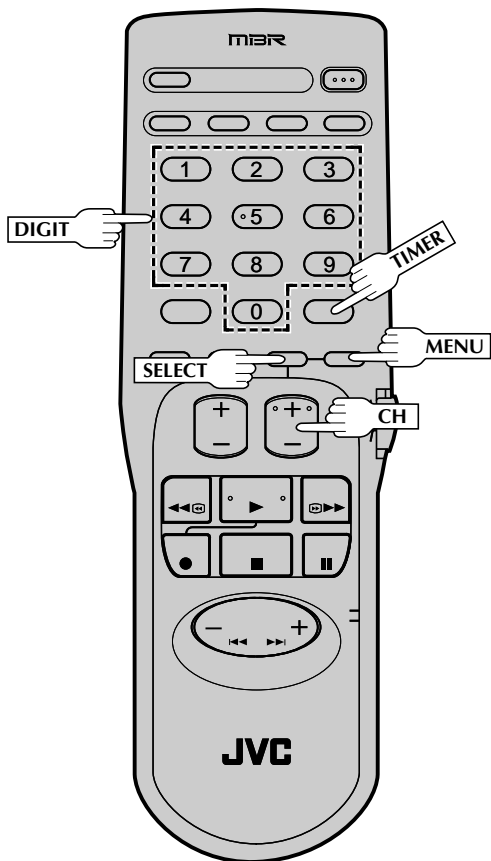
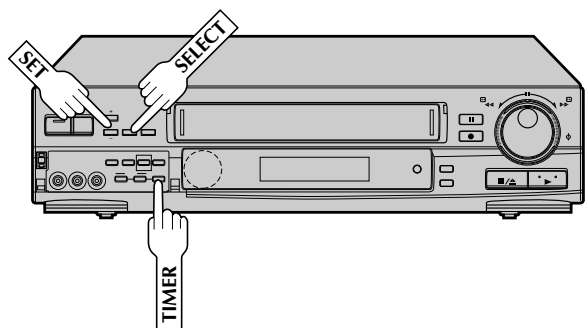

6 CHECK/CORRECT INPUT DATA

If the data is correct as it is, go to step 7. If not, press **SELECT** until the item you want to change begins to blink. Then press the **SET +/-** to obtain the desired setting.

7 RETURN TO NORMAL SCREEN

Press **MENU** as many times as necessary.

- Press just once to access the Auto Timer screen (pg. 43).

8 ENGAGE TIMER MODE

Press **TIMER**. The VCR turns off automatically.

NOTES:

- To disengage the timer before recording starts, press **TIMER** again. Pressing once more re-engages it.
- In case of a power failure after programming, the VCR's memory backup keeps your selections for approximately 60 minutes.
- When timer-recording cable channels received through a Cable Box, be sure to keep the Cable Box set to ON.

Instant Timer Recording (ITR)

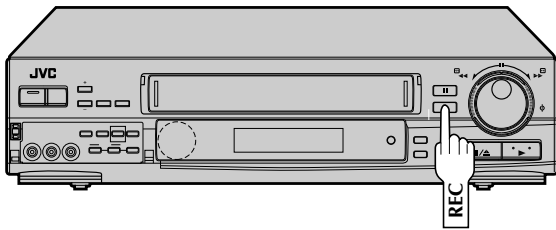

This easy method lets you record for from 30 minutes to 9 hours (selectable in 30-min. increments), and shuts the VCR off after recording is finished.

1

START RECORDING

Press **REC** on the front panel.

2

ENGAGE ITR MODE

Press **REC** again. ITR blinks and 0:30 appears on the front display panel.

3

SET RECORDING DURATION

If you want to record for more than 30 minutes, press **REC** to extend the time. Each press extends recording time by 30 minutes.

NOTES:

- You can only perform ITR using the **REC** button on the VCR's front panel.
- After you set the time, the previous display reappears.
- To check the remaining time, press **REC** once during recording and the remaining time will be displayed for about 5 seconds. Be careful not to press **REC** again within these 5 seconds, or you will round the recording time up to the next 30 minute increment.

On-Screen Timer Programming

* Refer to the illustration on page 41.

You can directly program the VCR's timer to record up to 8 shows, as far as a year in advance. Remember, the clock must be set before you can program the timer (☞ pg. 8 or 9).

1

LOAD A CASSETTE

Make sure the record safety tab is intact. If not, cover the hole with adhesive tape, then load.

- The VCR comes on, and the counter is reset, automatically.

2

ACCESS ON-SCREEN MENU

Press **MENU** as many times as necessary to bring up the Main Menu screen.

3

ACCESS PROGRAM SET SCREEN

Make sure the arrow is to the left of "PROGRAM SET", then press **SELECT**.

PROGRAM 1	
DATE	--/--
START	--:-- AM
STOP	--:-- AM
CHANNEL	-- SP
PRESS (SELECT, SET+/-)	
PRESS (MENU) TO END	

4

SELECT PROGRAM NUMBER

Press **SET +/-** to select a vacant program number, then press **SELECT**. The first time you do this, all numbers will be vacant, so just press **SELECT** when the screen appears.

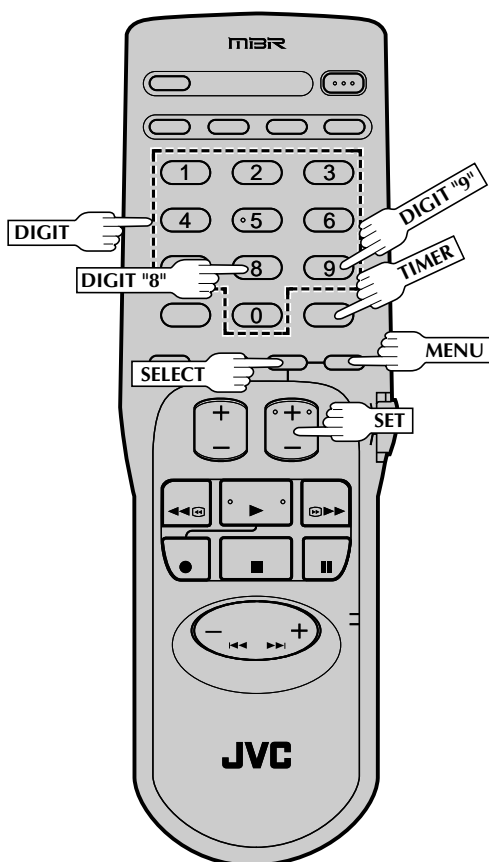
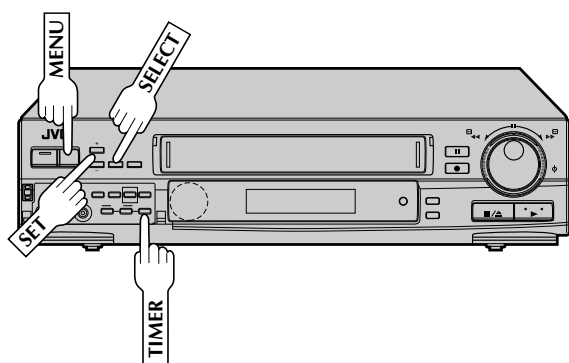
**EXAMPLE**

If you program the VCR to timer record a show on September 6 on channel 40 from 12:00 noon to 1:00 PM in SP mode, the screen will look like this:

PROGRAM 1	
DATE	9/6 SUN
START	12:00 PM
STOP	1:00 PM
CHANNEL	40 SP

PRESS (SELECT, SET+/-)
PRESS (MENU) TO END

5 SET PROGRAM INFORMATION

Press **SET +/-** to set the month, then press **SELECT**. The day display begins blinking. Repeat the procedure to set the day, start time, stop time, channel and tape speed. To set the channel you can also use the **DIGIT** keys.

- Do not use the **SET -** button to set the date.

** You can record selected programs at the same time every weekday, or once a week. Before entering the month or day, press **DIGIT** key "8" (DAILY) or "9" (WEEKLY). Either "DAILY" or "WEEKLY" appears. Press again and "DAILY" or "WEEKLY" disappears. For weekly recording, the desired date for the day of the week must be entered.

6 MAKE CORRECTIONS

To change any of the settings, press **SELECT** until the item you want to change begins blinking. Then set as in step 5.

7 RETURN TO NORMAL SCREEN

Press **MENU** as many times as necessary.

- Press just once to access the Auto Timer screen (pg. 43).

8 ENGAGE TIMER MODE

Press **TIMER**. The VCR turns off automatically.

NOTES:

- To disengage the timer before recording starts, press **TIMER** again. Pressing once more re-engages it.
- In case of a power failure after programming, the VCR's memory backup keeps your selections for approximately 60 minutes.
- If you select "PROGRAM SET" without having set the date and time, an error message appears. Follow its instructions.
- If you enter a start time that has already passed, "ERROR" appears on the screen and flashes.
- Programs that start after midnight must have the next day's date.
- After timer recording is completed, the VCR's power goes off automatically.
- You can program the timer while a regular recording is in progress; the on-screen menu will not be recorded.
- If the end of tape is reached during timer recording, the cassette is automatically ejected.
- When timer-recording cable channels received through a Cable Box, be sure to keep the Cable Box set to ON.

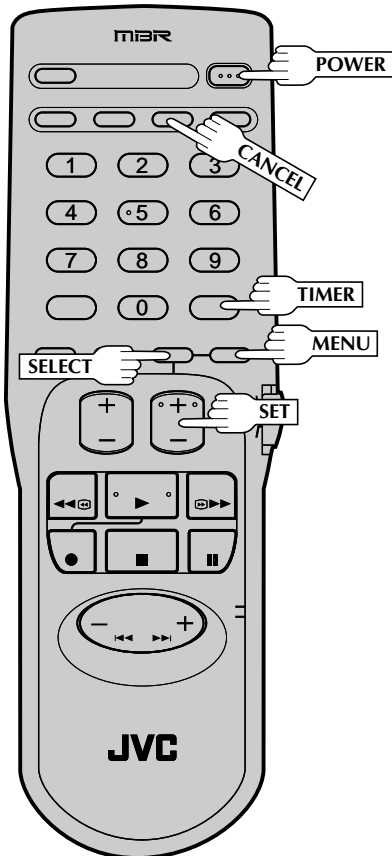
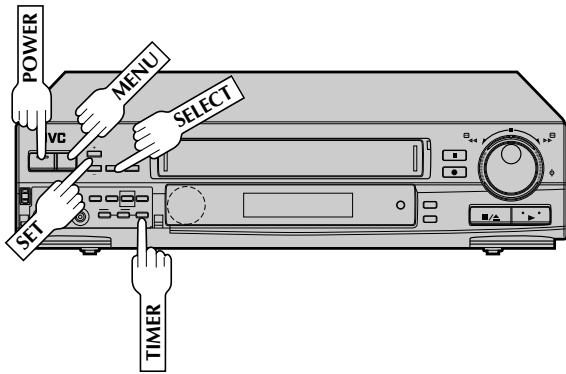

Check And Cancel Programs

1 DISENGAGE TIMER

Press **TIMER**, then press **POWER**.

2 ACCESS MAIN MENU SCREEN

Press **MENU** as many times as necessary.

3 ACCESS PROGRAM SET SCREEN

Press **SET +/-** to place the arrow next to "PROGRAM SET", then press **SELECT**.

4 CHECK PROGRAM INFORMATION

Press **SET +/-** to check the programs in succession.

To Cancel A Program . . .

5 CANCEL A PROGRAM

Press **CANCEL**.

- Repeat steps 4 and 5 as many times as necessary.

6 RETURN TO NORMAL SCREEN

Press **MENU** as many times as necessary. If there are still programs remaining, go to step 7.

7 RE-ENGAGE TIMER

Press **TIMER** again.

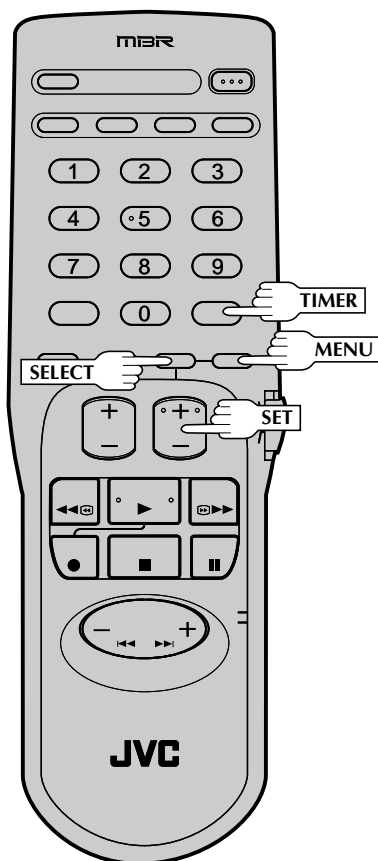
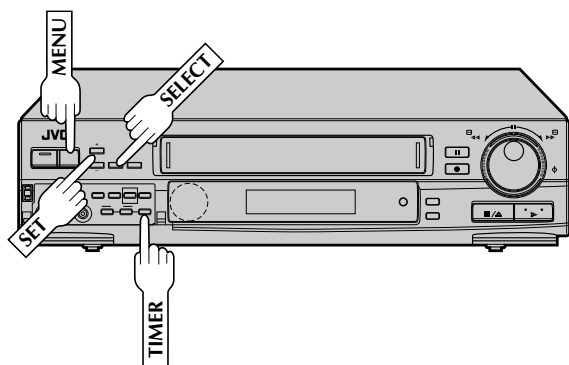

Auto Timer

When the Auto Timer is set to ON the timer is automatically engaged when the VCR's power is turned off and automatically disengaged when the VCR is powered back on.

1 ACCESS MAIN MENU SCREEN

Press **MENU** as many times as necessary.

2 ACCESS FUNCTION SET SCREEN

Place the arrow next to "FUNCTION SET" by pressing **SET +/-**, then press **SELECT**.

3 ACCESS AUTO TIMER SCREEN

Place the arrow next to "AUTO TIMER" by pressing **SET +/-**, then press **SELECT**. Now skip to step 2 of the procedure below.

Or, during on-screen timer programming ...

1 ACCESS AUTO TIMER SCREEN

In step 7 in the VCR Plus+ Timer Programming procedure (pg. 39) or in step 7 in the On-Screen Timer Programming procedure (pg. 41), press **MENU**.

2 SELECT MODE

Place the arrow next to your choice ("ON" or "OFF") by pressing **SET +/-**.

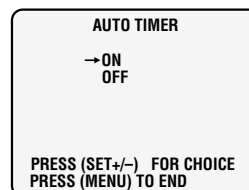

3 RETURN TO NORMAL SCREEN

Press **MENU** as many times as necessary.

NOTE:

For safety, when **AUTO TIMER** is set to "OFF", all other VCR functions are disabled while the Timer mode is engaged. To disengage the timer, press **TIMER**.

Edit From A Camcorder

You can use a camcorder as the player and your VCR as the recorder.

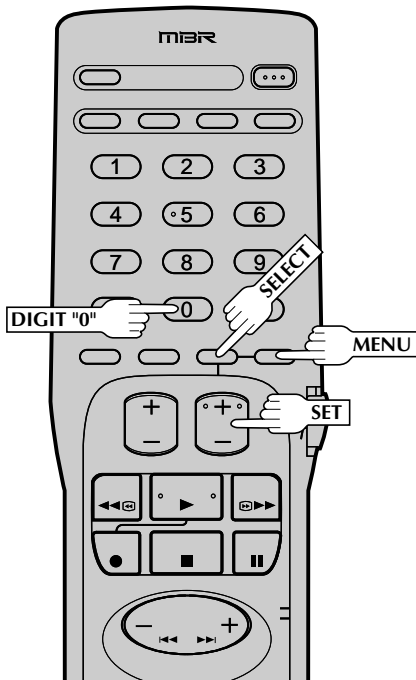
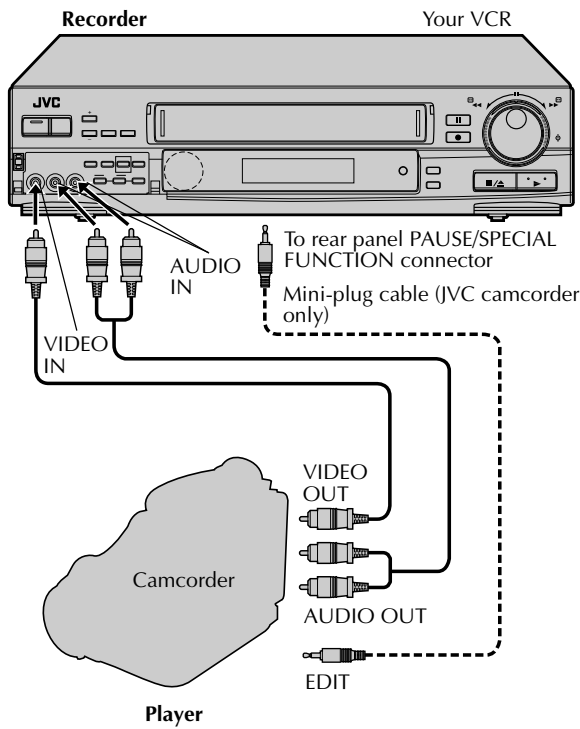

- ## 1 MAKE CONNECTIONS

Connect an AV cable between the camcorder's VIDEO OUT and AUDIO OUT connectors and your VCR's VIDEO IN and AUDIO IN connectors.

 - When a Master Edit Control-equipped JVC camcorder is used, the camcorder is capable of controlling your VCR. The mini-plug cable is a mono 3.5 mm mini-plug to mono 3.5 mm mini-plug connector.
 - If connecting to a camcorder with a monaural output, connect the audio output connector on the camcorder to the AUDIO IN L of the VCR.
- ## 2 LOAD A CASSETTE

Insert the cassette to be recorded on into the recorder.
- ## 3 SET RECORDER'S INPUT MODE

Press **DIGIT** key "0" to set to AUX.
- ## 4 ACCESS MAIN MENU SCREEN

Press **MENU** as many times as necessary.
- ## 5 ACCESS FUNCTION SET SCREEN

Press **SET +/-** to place the arrow next to "FUNCTION SET", then press **SELECT**.

If you're using a JVC Master Edit Control-equipped camcorder — step 6
If not — step 9
- ## 6 ACCESS SPECIAL FUNCTION SCREEN

Press **SET +/-** to place the arrow next to "SPECIAL FUNCTION", then press **SELECT**.
- ## 7 SELECT MODE

Press **SET +/-** to place the arrow next to "R.A. EDIT/PAUSE".

SPECIAL FUNCTION

→R.A. EDIT/PAUSE
AV COMPU-LINK

PRESS (SET+/-) FOR CHOICE
PRESS (MENU) TO END

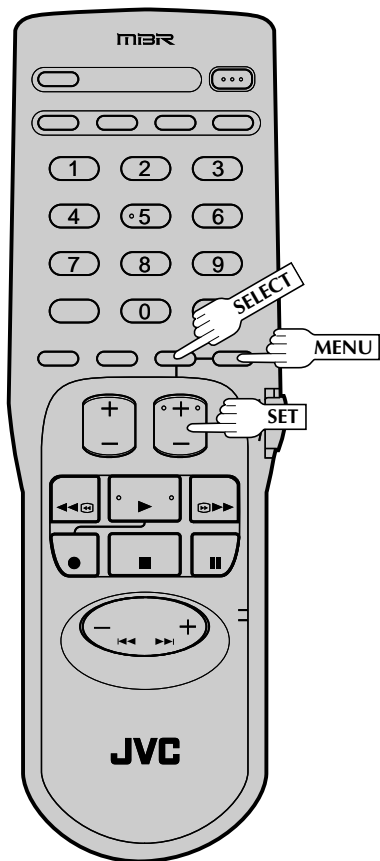
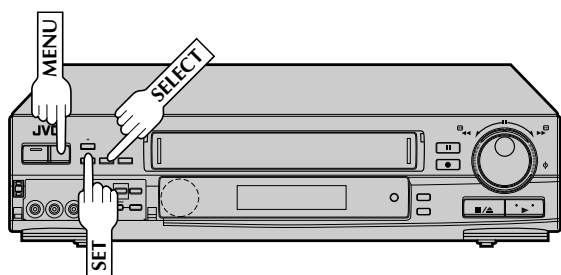

8 RETURN TO FUNCTION SET SCREEN

Press MENU.

9 ACCESS TAPE DUB MODE SCREEN

Press SET +/- to place the arrow next to "TAPE DUB MODE", then press SELECT.

10 SELECT MODE

Place the arrow next to "ON" by pressing SET +/-.

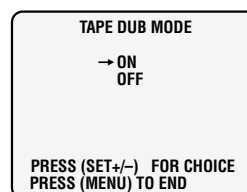

11 RETURN TO NORMAL SCREEN

Press MENU as many times as necessary.

12 START PLAYER

Set the camcorder to its play mode.

NOTE:

If the camcorder is equipped with a superimpose/OSD disable feature then set its superimpose or display feature to OFF before pressing play.

13 START RECORDER

Set your VCR to its record mode.

- If you are using a Master Edit Control-equipped JVC camcorder, it can put the recorder automatically into Record mode. (Refer to camcorder's instruction manual.)

NOTE:

- Connections made to the front panel VIDEO and AUDIO inputs automatically override any rear panel VIDEO/AUDIO or S-VHS input connections. If you wish to edit with another machine connected to the rear input connectors, make sure that there is nothing connected to the front connectors.

Edit To Or From Another VCR

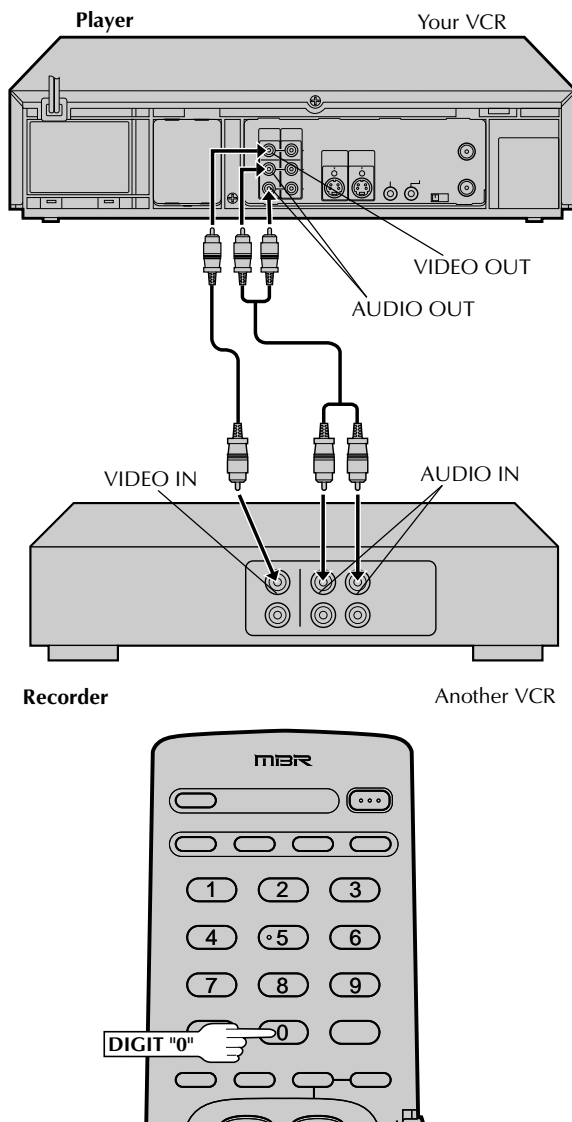

You can use your VCR as the player or the recorder.

1 MAKE CONNECTIONS

Connect an AV cable between the player's VIDEO OUT and AUDIO OUT connectors and the recorder's VIDEO IN and AUDIO IN connectors.

- When using your VCR as the recorder and a monaural VCR as the player, connect the player's AUDIO OUT connector to the AUDIO IN L connector on the recorder.

2 LOAD CASSETTES

Insert the playback cassette into the player and the cassette to be recorded on into the recorder.

3 ENGAGE TAPE DUBBING MODE

Follow steps 4, 5, 9–11 from the "Edit From A Camcorder" section (☞ pg. 44)

4 SET RECORDER'S INPUT MODE

Set to AUX. With this VCR, press **DIGIT** key "0" (AU appears on the front display panel in place of a channel number).

5 START PLAYER

Set to its play mode.

NOTE:

If the player is equipped with a superimpose/OSD disable feature then set "SUPERIMPOSE" to OFF before pressing **PLAY** (☞ pg. 29).

6 START RECORDER

Set to its record mode.

NOTE:

- Connections made to the front panel VIDEO and AUDIO inputs automatically override any rear panel VIDEO/AUDIO or S-VHS input connections. If you wish to edit with another machine connected to the rear input connectors, make sure that there is nothing connected to the front connectors.

Advantages Of S-VHS VCRs

You can edit from VHS to S-VHS, from S-VHS to VHS, or from S-VHS to S-VHS.

- From VHS to S-VHS (VIDEO-VIDEO connection): Record VHS playback signals in the S-VHS mode. Although the picture quality is inherently limited by that of the original, the edited tape has better picture quality than those made by VHS-to-VHS editing.

- From S-VHS to VHS (VIDEO-VIDEO connection): Because the picture quality of the source material is very high, the edited tape has better picture quality than those made by VHS-to-VHS editing.
- From S-VHS to S-VHS (S-VIDEO connection): All signals will be transferred without degradation.

Assemble Editing

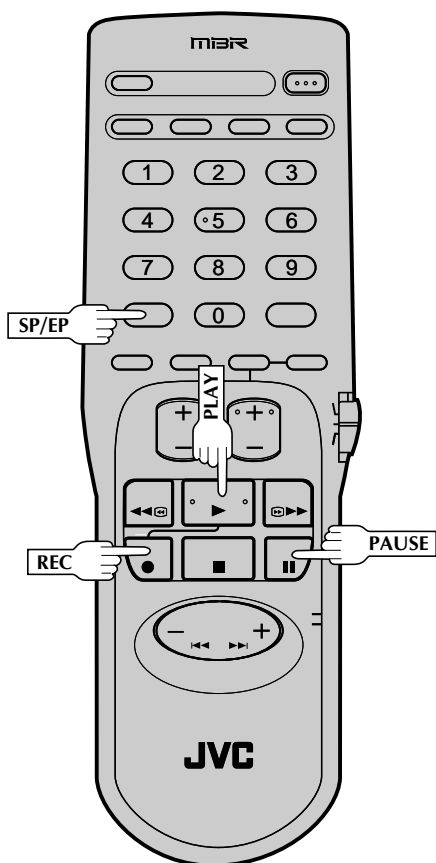
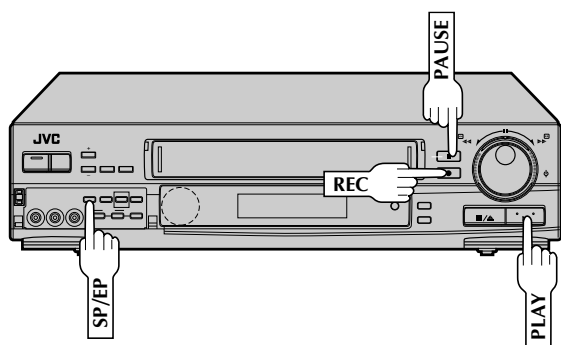

Assemble Editing adds one recorded scene to another in succession.

To use your VCR as the recorder ...

- 1 LOAD CASSETTES**
Insert the original cassette in the player, and the recording cassette in the recorder.
- 2 SET TAPE SPEED**
Set to "SP" or "EP" by pressing the SP/EP button.
- 3 ENGAGE TAPE DUBBING MODE**
Follow steps 4, 5, 9–11 from the "Edit From A Camcorder" section (pg. 44)
- 4 ENGAGE RECORD-STANDBY MODE**
Press and hold PAUSE, and press REC.
- 5 FIND EDIT START POINT**
Play back the original tape until you reach the scene to be edited.
- 6 START EDITING**
When you reach the scene on the original tape to be edited, press PLAY to initiate the recorder's record mode.
- 7 STOP EDITING**
Press PAUSE to pause the tape in the recorder.
- 8 CONTINUE EDITING**
Repeat steps 5 through 7 to add additional scenes.

NOTE:

Assemble Editing is also possible using your VCR as the playback deck.

Insert Editing

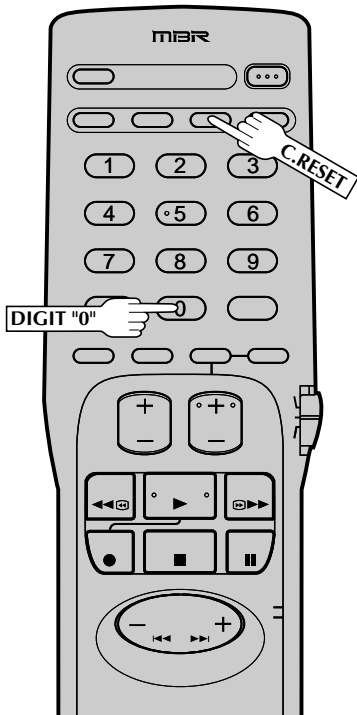
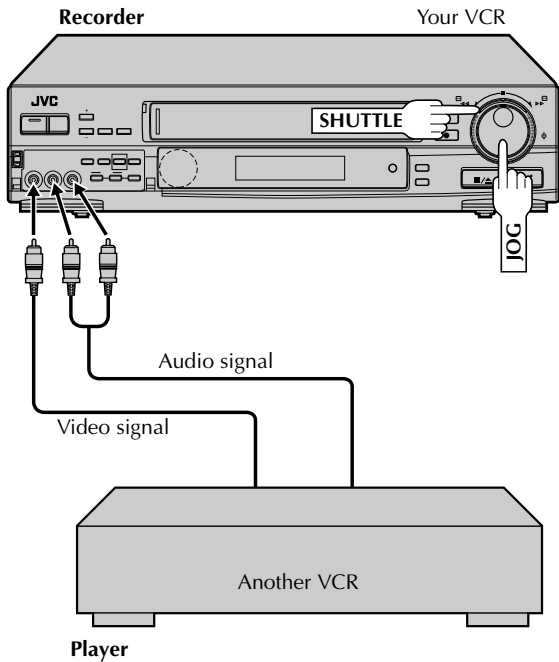

Insert editing replaces part of the recorded scene with new material. Both the picture and Hi-Fi audio soundtrack are replaced with new ones, while the normal audio soundtrack remains unchanged. If you wish to change the normal audio track as well, use the audio dubbing function simultaneously. Use your VCR as the recorder.

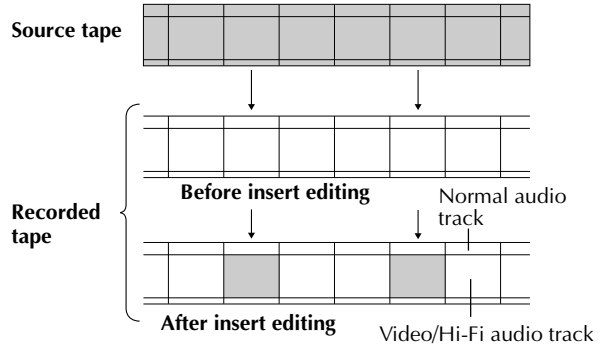

1 MAKE CONNECTIONS

Connect the player's VIDEO OUT and AUDIO OUT connectors to your VCR's VIDEO IN and AUDIO IN on the front panel.

2 SET INPUT MODE

Press DIGIT key "0". "AU" appears in place of a channel number.

3 ENGAGE TAPE DUBBING MODE

Follow steps 4, 5, 9–11 from the "Edit From A Camcorder" section (pg. 44)

4 LOCATE END POINT

Load the recording cassette into your VCR, and play it back to determine the edit-out point (the end of the segment to be replaced) using the JOG/SHUTTLE controls.

- Releasing the JOG/SHUTTLE controls engages the Still mode .

5 RESET THE COUNTER

Press C.RESET to change the counter display to "0H00M00S".

6 LOCATE START POINT

Determine the edit-in point (the beginning of the segment to be replaced) using the JOG/SHUTTLE controls.

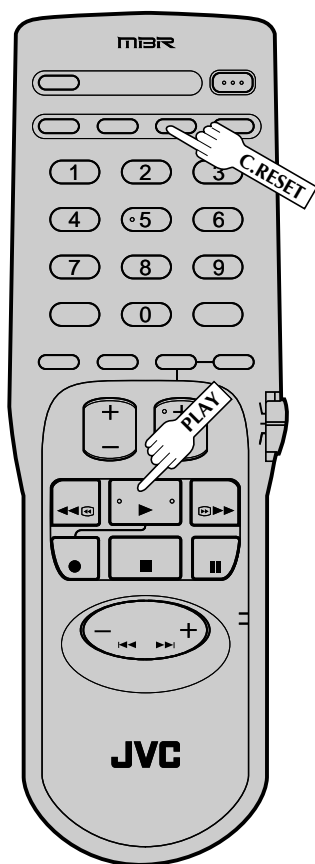
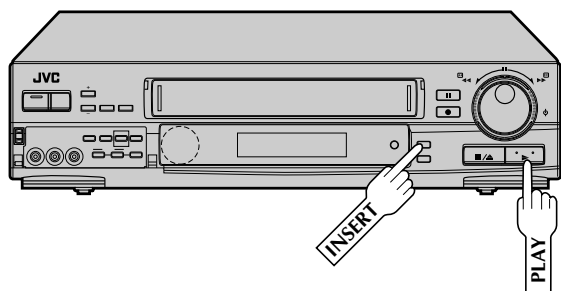

7 ENGAGE INSERT EDITING

Press **INSERT**.

- Your VCR enters the Insert-Pause mode. (REC, PLAY and PAUSE light up on the front display panel.)
- The TV screen changes from the still picture to the input source you are going to record.

8 START EDITING

Load the source cassette into another VCR and play back the segment that is to be inserted. When you reach the start of section of source tape that you wish to insert, press **PLAY** to start the tape in your VCR; Insert Editing begins at this point.

- PLAY and REC are displayed on the front display panel.

9 END INSERT EDITING

At counter "0H00M00S", Insert Editing will stop automatically while the tape continues running in the Play mode. If you wish to stop Insert Editing before the specified edit-out point, press **C.RESET**.

FOR AV INSERT EDITING

If you want to replace the picture, Hi-Fi audio soundtrack and normal audio soundtrack all at the same time... In step 7 above, after you press **INSERT**, press **A. DUB.** also. (REC and PLAY blink and PAUSE lights up on the display panel.)

NOTES:

- Suitable leads can be obtained from your dealer.
- Insert editing is not possible with cassettes whose safety tab has been removed.
- In insert editing, the recording speed (SP/EP) is determined by the previous recording to be replaced. If the previous recording's speed changes within a single edit, the inserted picture will be distorted at the switching point.
- A small portion of the recording which precedes an insert edit may become erased.
- Insert Editing is also possible using the rear connectors.
- Connections made to the front panel VIDEO and AUDIO inputs automatically override any rear panel VIDEO/AUDIO or S-VHS input connections. If you wish to edit with another machine connected to the rear input connectors, make sure that there is nothing connected to the front connectors.

Random Assemble Editing

This function makes it easier to create edited videos when your VCR is used as the source player in combination with another VCR equipped with a Remote PAUSE Connector. You can pre-program up to 8 scenes or "cuts" for automatic editing in the sequence you have specified.

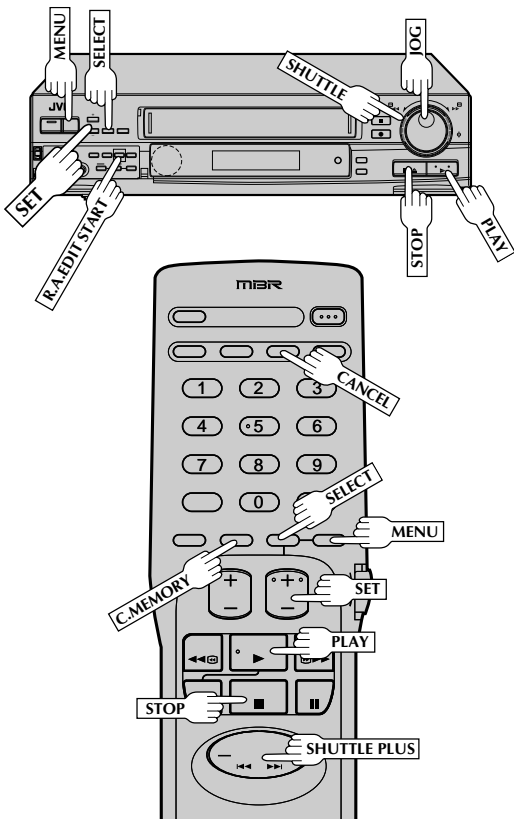
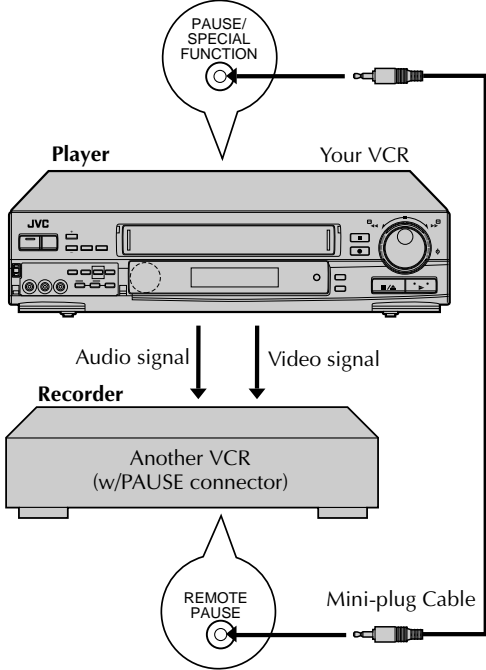

1

MAKE CONNECTIONS

Connect your VCR's VIDEO OUT and AUDIO OUT connectors to the VIDEO IN and AUDIO IN connectors on the recording deck, and connect your VCR's PAUSE/SPECIAL FUNCTION connector to the PAUSE connector on the recording deck.

- If the recording deck doesn't have a PAUSE connector, connect to the R.A. EDIT connector instead.
- The Mini-plug cable is a mono 3.5 mm mini-plug to mono 3.5 mm mini-plug connector.

2

PREPARE FOR EDITING

Perform steps 2 – 11 on page 44, "Edit From A Camcorder".

NOTE:

If you mistakenly select "AV COMPU LINK" in step 7 on page 44, an error message appears when you finish step 6. Make sure "R.A. EDIT/PAUSE" is selected before you continue.

-ERROR-
CHOOSE SPECIAL FUNCTION ON MAIN MENU AND SELECT R.A. EDIT/PAUSE

BEFORE YOU BEGIN R.A. EDIT

PRESS (MENU) TO MAIN MENU

3

LOAD SOURCE CASSETTE

Insert the source cassette into your VCR.

4

START SOURCE PLAYBACK

Press PLAY.

5

ACCESS MAIN MENU SCREEN

Press MENU as many times as necessary to bring up the Main Menu screen.

6

ACCESS R.A. EDIT SCREEN

Place the arrow next to "R.A. EDIT" by pressing SET +/-, then press SELECT.

MAIN MENU

PROGRAM SET
FUNCTION SET
TUNER SET
CUSTOM SET
→ R.A. EDIT

PRESS (SELECT, SET+/-)
PRESS (MENU) TO END

- The screen is superimposed on the video playback in step 7.

7

LOCATE EDIT-IN POINT

Find the point on the source tape from where you want the edited scene to begin by pressing **SHUTTLE PLUS** $\lll\lll$, or **JOG/SHUTTLE** then press **SELECT**.

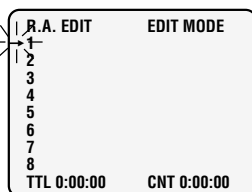

- The edit-in point is registered in memory and appears on the screen.
- You can also perform an Index Search (if index marks have been previously recorded on the tape at the desired points \square pg. 30) to find the points you want, but this will result in reduced accuracy.

8

LOCATE EDIT-OUT POINT

Find the point where you want the edited scene to end by pressing **SHUTTLE PLUS** $\lll\lll$, or **JOG/SHUTTLE** then press **SELECT**.

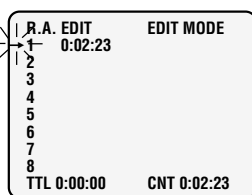

- The edit-out point is registered in memory and appears on the screen.
- The total time of the edited scenes is displayed to the right of "TTL".
- Repeat steps 7 and 8 for each additional scene.

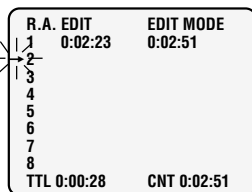

9

PREPARE RECORDING DECK

Engage its Record-Standby mode.

10

START R.A. EDIT

Press **R.A. EDIT START** on the VCR or **C.MEMORY** on the remote control.

- Automatic editing begins; all the specified scenes are copied to the recording deck in the order they were registered.
- The on-screen display remains while your VCR searches for each scene (blinking cursor indicates scene currently being searched for), but disappears during actual editing.
- During scene search, the recording deck automatically enters its Record-Standby mode. "SEARCHING" appears on the screen.
- When all registered scenes have been edited, your VCR enters the Still mode, the recording deck enters its Record-Standby mode, and the cursor blinks at the next available number.

11

END R.A. EDIT

Press **MENU** as many times as necessary to return to the normal screen, and engage the Stop mode for the both VCRs.

NOTES:

- You can also monitor the sound when searching for scenes you want to edit in steps 7 – 8. Since you can hear the soundtrack during selection, you can avoid abrupt or unnatural sounding scene-to-scene transitions.
- When editing, there may be a discrepancy of about 2 seconds on the source tape between the locations you chose as edit-in/-out points and the locations the VCR recognizes as those points.
- There are no limitations for R.A. Edit list (such as repeat segments, negative counter values, segments out of order). Only the start-stop sequence has to be in the normal play direction.
- For any scene, the edit-out point must have a counter reading that is at least 1 second after the corresponding edit-in point. Any less than 1 second and the edit-out point will not be registered.
- Since the source VCR prerolls during Random Assemble Editing, there must be at least 15 seconds worth of recorded material prior to any edit-in point on the source tape.
- If the search time for an edit-in point exceeds 5 minutes, the recording deck enters its Stop mode and editing will not take place.

To Make Corrections . . .

. . . during step 7 or 8, you can cancel registered in and out points by pressing **CANCEL** on the remote control. Each time you press, the preceding point is erased.

- If, for example, you have registered 5 sets of in and out points and want to reset the first set, you have to press **CANCEL** until all points after the first set have been erased. Reenter them after you've repaired the first set of points.

Memory Capacity

Random Assemble Editing shares memory space with the VCR's timer. If there are programs occupied by timer-recording data, those spaces cannot be used to register edit-in and -out points — meaning you won't be able to edit 8 scenes.

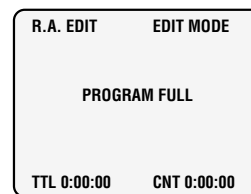

- When all 8 programs are full, "PROGRAM FULL" appears on the R.A. EDIT screen.
- To cancel a program, see page 42.

RM-V403U Multi-Brand R.A. Edit Controller (Not supplied)

By connecting this controller to your VCR's R.A. EDIT connector, you can perform Random Assemble Editing in combination with a second non-JVC VCR. The controller is compatible with various major VCR brands. For compatible systems and availability, please consult your JVC dealer.

Audio Dubbing

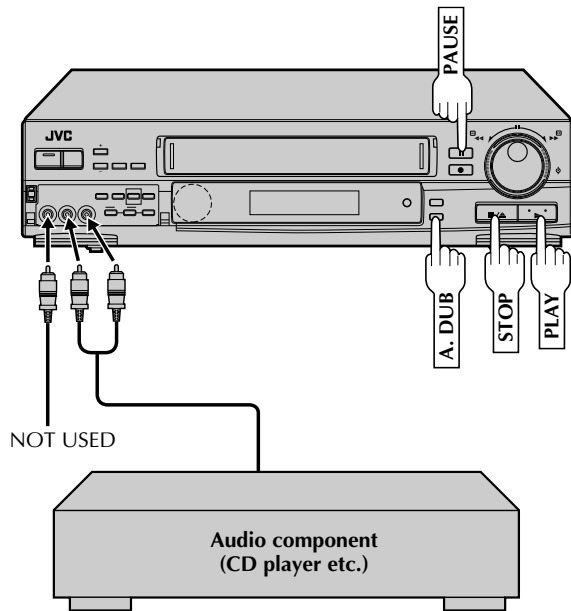

NOTES:

- When monitoring the sound during Audio Dubbing, the normal soundtrack is automatically selected. If you wish to hear the Hi-Fi or mixed sound (Hi-Fi + Normal soundtracks), refer to the "Select The Soundtrack" section (pg. 28) and select the soundtrack you wish to hear.
- Audio dubbing stops automatically when the counter reaches "0H00M00S", and the VCR enters the Play mode. Check the counter reading before dubbing.
- Audio dubbing is also possible using the rear AUDIO IN connectors.
- Audio dubbing cannot be performed on a cassette that has had its record safety tab removed.
- When playing back an audio-dubbed tape, refer to the "Select The Soundtrack" section (pg. 28) to select the soundtrack you wish to hear.
- It may be unlawful to record or play back copyrighted material without the consent of the copyright owner.

Audio dubbing replaces the normal audio sound of a previously recorded tape with a new soundtrack. Use your VCR as the recorder.

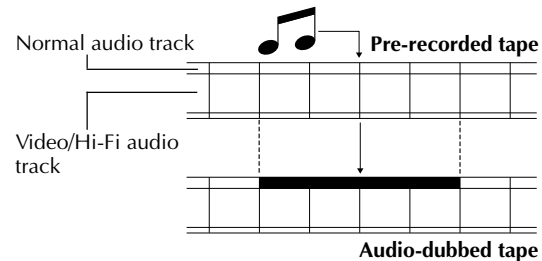

1 MAKE CONNECTIONS

Connect an audio component to the AUDIO IN L + R and VIDEO IN connectors on the VCR's front panel. *When connecting monaural equipment, use only the VCR's AUDIO IN L connector.

- By connecting to the front panel VIDEO IN connector, the front panel connectors will automatically override any rear panel Video/Audio input connections.

2 SET INPUT MODE

Press **DIGIT** key "0" on the remote control. "AU" appears in place of a channel number.

3 LOCATE START POINT

Press **PLAY** to start playback of the tape in your VCR, and press **PAUSE** when you find the point where you want to start dubbing.

4 ENGAGE AUDIO DUBBING

Press **A. DUB**.

- Your VCR enters the Audio Dubbing Pause mode. (REC blinks, PLAY and PAUSE light up on the front display panel.)

5 START DUBBING

Engage the audio component's Play mode, then press **PLAY** to start the tape in your VCR. Audio dubbing begins at this point.

- REC blinks and PLAY is displayed on the front display panel.
- To stop dubbing temporarily, press **PAUSE**. Press **PLAY** to resume dubbing.

6 END AUDIO DUBBING

Press **STOP** to stop the tape in your VCR, and engage the audio component's Stop mode.

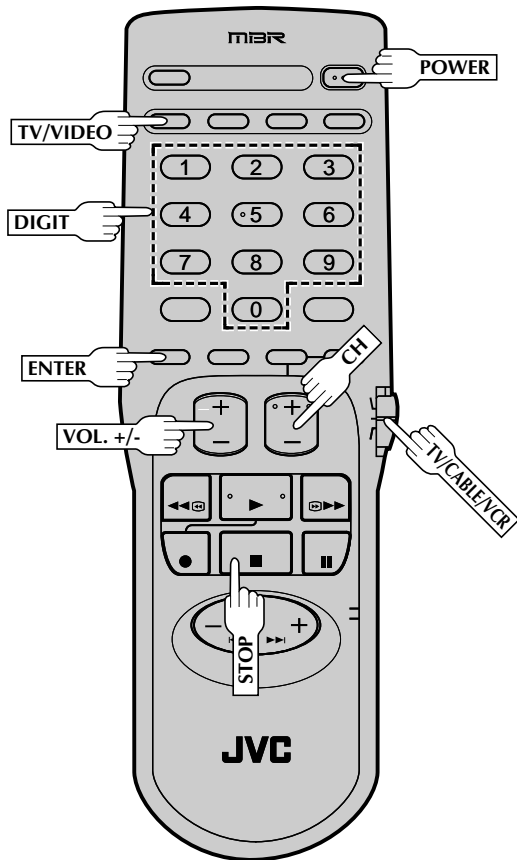

TV Multi-Brand Remote Control

The VCR's remote control can control several functions on JVC remote control TVs and on the brands of remote control TVs listed below.

1

TURN ON THE TV

Turn the power on using the TV's remote control.

2

SET REMOTE CONTROL MODE

Set the **TV/CABLE/VCR** switch on the VCR's remote control to TV.

3

SET TV BRAND CODE

Refer to the chart below. While holding down **POWER** on the VCR's remote control, enter your TV's brand code using the **DIGIT** keys, then press **STOP**.

- Once you have set the remote control to operate the TV, you don't have to repeat this step until you replace your remote control's batteries.
- PANASONIC has two codes. If the TV does not function with one code, try entering the other.

4

OPERATE TV

First, press **POWER** on the remote to see if the TV's power goes off as it should. If it does, try other operations.

- The **POWER**, **TV/VIDEO**, **CH +/-**, **VOL +/-** and **DIGIT** keys on the remote can all be used to operate the TV.
- To return the remote to VCR control, set the **TV/CABLE/VCR** switch to **VCR**.

NOTE:

Depending on the kind of TV, there may be cases where some or all functions cannot be operated using the remote control.

TV BRAND NAME	BRAND CODE
JVC	01
MAGNAVOX	02
MITSUBISHI	03
PANASONIC	04, 11
RCA	05
SHARP	06
SONY	07
TOSHIBA	08
ZENITH	09
HITACHI	10
SAMSUNG	12
SANYO	13

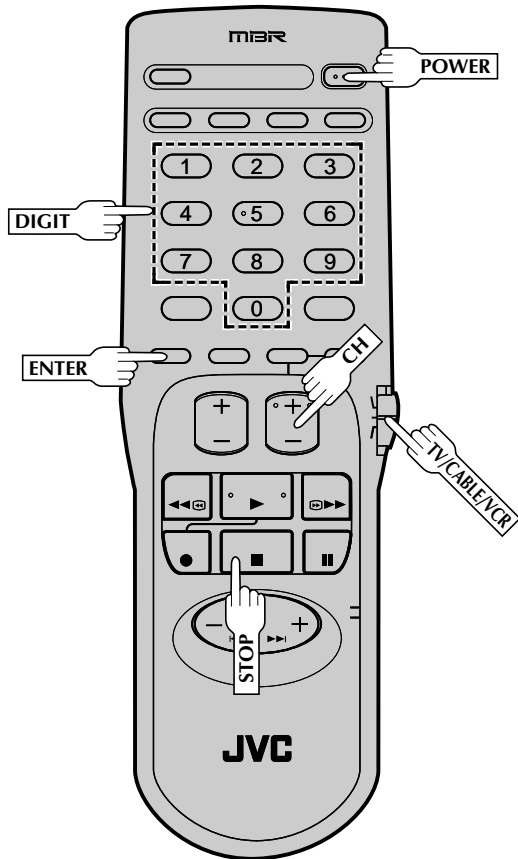

Cable Box Multi-Brand Remote Control

The VCR's remote control can control functions on the brands of cable boxes listed below. Some cable box brands have more than one code. If your cable box does not function with a specified code, try other codes.

1 TURN ON THE CABLE BOX

Turn the power on using the cable box's remote control.

2 SET REMOTE CONTROL MODE

Set the TV/CABLE/VCR switch on the VCR's remote control to **CABLE**.

3 ENTER CABLE BOX BRAND

While holding down **POWER** on the VCR's remote control, use the **DIGIT** keys to enter the cable box brand number from the chart below and then press **STOP**.

- Once you have set the remote control to operate the cable box, you don't have to repeat this step until you replace the remote control's batteries.

4 OPERATE CABLE BOX

First, press **POWER** to see if the cable box's power goes off as it should. If it does, try other functions (**CH +/-** and the **DIGIT** keys can be used to operate the cable box).

- For some brands of cable box, you must press **ENTER** after having pressed the **DIGIT** keys.
- To return the remote to VCR control, set the TV/CABLE/VCR switch to **VCR**.

CABLE BOX BRAND NAME	BRAND CODE
GENERAL INSTRUMENTS	01, 02, 03, 04, 05, 06, 07, 08
HAMLIN	15, 16, 17, 18
JERROLD	01, 02, 03, 04, 05, 06, 07, 08
OAK	19, 20, 21
PANASONIC	24, 25, 26
PIONEER	13, 14
RCA	24, 25, 26
REGAL	15, 16, 17, 18
SCIENTIFIC ATLANTA	09, 10
SIGMA	19, 20, 21
SPRUCER	24, 25, 26
TOCOM	22, 23
ZENITH	11, 12

NOTES:

- You must set the cable box brand for your remote control and the cable box brand for your Cable Box Controller (pg. 18) separately. The list of cable box brands that can be controlled by your remote control is different from the list of cable box brands that can be controlled by your cable box controller.
- It is possible that the remote control will not operate your cable box even if the cable box's channels automatically change during timer recording using the Cable Box Controller.

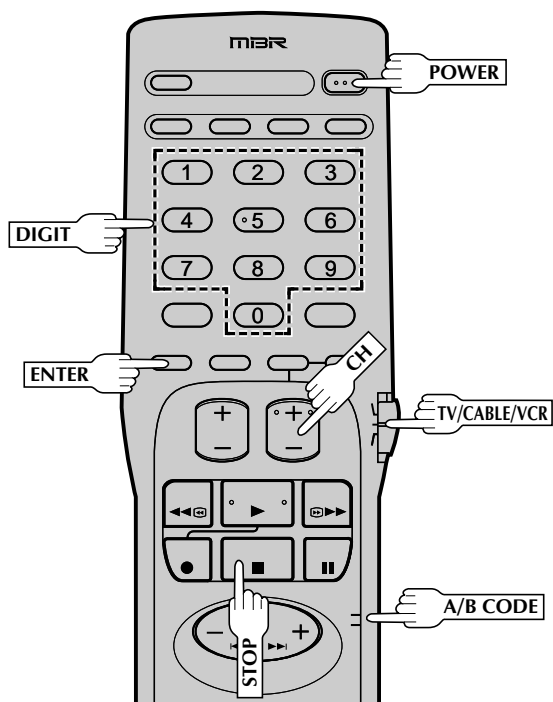

Control Two JVC VCRs

The supplied remote control is capable of controlling two JVC VCRs independently using the **A/B CODE** switch. You can set this VCR so it responds to remote commands only when the switch is set to **B**, and another VCR so it responds to commands when the switch is set to **A**. The switch is preset to **A** because this VCR normally responds to A-code signals. You can easily modify this VCR to accept B-code commands.

1 UNPLUG VCR'S POWER CORD

Unplug from the AC outlet.

2 SET A/B CODE SWITCH

Set the **A/B CODE** switch on the remote control to **B**.

3 PLUG IN POWER CORD

Plug back in to the AC outlet.

4 TURN VCR POWER ON

Press **POWER** on the remote.

- You can control two VCRs with the same remote control by toggling the slide switch between A and B.

The VCR will now respond only to B-code commands.

DSS Receiver Multi-Brand Remote Control

The VCR's remote control can control functions on the brands of DSS (Digital Satellite System) receivers listed below.

1 TURN ON THE DSS RECEIVER

Turn the power on using the DSS receiver's remote control.

2 SET REMOTE CONTROL MODE

Set the **TV/CABLE/VCR** switch on the VCR's remote control to **CABLE**.

3 ENTER DSS RECEIVER BRAND

While holding down **POWER** on the VCR's remote control, use the **DIGIT** keys to enter the DSS receiver brand number from the chart below and then press **STOP**.

- Once you have set the remote control to operate the DSS receiver, you don't have to repeat this step until you replace the remote control's batteries.

4 OPERATE DSS RECEIVER

First, press **POWER** to see if the DSS receiver's power goes off as it should. If it does, try other functions (**CH +/-** and the **DIGIT** keys can be used to operate the DSS receiver).

- Depending on the DSS receiver you may have to press **ENTER** after having pressed the **DIGIT** keys.
- To return the remote to VCR control, set the **TV/CABLE/VCR** switch to **VCR**.

NOTE:

Depending on type of DSS receiver, there may be cases where some or all functions cannot be operated using the remote control.

DSS BRAND NAME	BRAND CODE
RCA	80
SONY	81





Before requesting service for a problem, use this chart and see if you can repair the trouble yourself. Small problems are often easily corrected, and this can save you the trouble of sending your VCR off for repair.

POWER		
SYMPTOM	POSSIBLE CAUSE	CORRECTIVE ACTION
1. The power won't come on.	<ul style="list-style-type: none"> • The power cord is disconnected. 	Connect the power cord.
2. The clock works, but the VCR's power won't come on.	<ul style="list-style-type: none"> • The TIMER mode is engaged with Auto Timer set to "OFF" (☞ pg. 43). 	Press TIMER to disengage.
3. The remote control won't function.	<ul style="list-style-type: none"> • The batteries are discharged. • The A/B CODE switch is in the wrong position. • The TV/CABLE/VCR switch is in the wrong position. 	Replace the dead batteries with new ones. Re-perform the A/B Code setting (☞ pg. 55). Set the switch to the position corresponding with the unit you want to operate.
TAPE TRANSPORT		
SYMPTOM	POSSIBLE CAUSE	CORRECTIVE ACTION
1. The cassette gets stuck partway during loading, and is ejected.	<ul style="list-style-type: none"> • The cassette was inserted incorrectly. 	Make sure the window side is up, the rear label side is facing you and the arrow on the front of the cassette is pointing towards the VCR. Then insert the cassette.
2. The tape stops during rewind or fast forward.	<ul style="list-style-type: none"> • The Counter Memory indicator ("M") is lit on the front display panel. 	Press C.MEMORY to disengage the Counter Memory mode and extinguish the indicator.
PLAYBACK		
SYMPTOM	POSSIBLE CAUSE	CORRECTIVE ACTION
1. The tape is running but the picture won't appear.	<ul style="list-style-type: none"> • If you're using the RF OUT connection (☞ pg. 6), the channel selector on the TV is set incorrectly. • If you're using the AV connection or S-VIDEO connection (☞ pg. 6 or 7), the TV receiver is set to the wrong mode. 	Set the channel selector to channel 3 or 4. Set the TV receiver to its AV mode.
2. Noise appears during visual search.	<ul style="list-style-type: none"> • This is normal. 	
3. Breaks are noticeable in Hi-Fi soundtrack.	<ul style="list-style-type: none"> • Automatic tracking is engaged. 	Engage and adjust tracking manually (☞ pg. 27).
4. The playback picture is blurred or interrupted, even though TV broadcasts are clear.	<ul style="list-style-type: none"> • The video heads may be dirty. 	The heads must be cleaned. Consult your JVC dealer (☞ pg. 64).
5. The Hi-Fi soundtrack cannot be heard.	<ul style="list-style-type: none"> • The AUDIO MONITOR option at the Function Set screen was set incorrectly. 	Set AUDIO MONITOR to "HI-FI" (☞ pg. 28).

RECORDING

SYMPTOM	POSSIBLE CAUSE	CORRECTIVE ACTION
1. Recording won't start.	<ul style="list-style-type: none"> • There's no cassette loaded. • The loaded cassette has had its record safety tab removed. 	<p>Insert a cassette.</p> <p>Remove the cassette and cover the hole with adhesive tape, or load a cassette on which the record safety tab is intact.</p>
2. TV broadcasts won't record properly.	<ul style="list-style-type: none"> • The VCR has been set to its AUX mode by mistake. 	<p>Set the VCR to the appropriate channel.</p>
3. Tape-to-tape editing won't work.	<ul style="list-style-type: none"> • The VCRs or the camcorder and the VCR have been incorrectly connected. • The power to one or more of the units has not been turned on. • The recorder's input mode has been set incorrectly. 	<p>Refer to the directions and the illustration under "Edit To Or From Another VCR" (pg. 46) or "Edit From A Camcorder" (pg. 44) and properly connect the units.</p> <p>Make sure the power to all units is on.</p> <p>Make sure nothing is connected to the front panel connectors if using a rear panel input connection.</p>

TIMER RECORDING

SYMPTOM	POSSIBLE CAUSE	CORRECTIVE ACTION
1. Timer recording won't work.	<ul style="list-style-type: none"> • The clock and/or the timer have been set incorrectly. • The timer is not engaged. • The VCR has not been set up properly. 	<p>Check or re-perform the clock/timer settings to ensure correctness.</p> <p>Press TIMER and check to make sure that TIMER appears on the front display panel.</p> <p>Re-perform the set-up procedures. Make sure you have compensated for Guide Channel and VCR or cable box channel number mismatches (pg. 20).</p>
2. On-screen timer programming won't work.	<ul style="list-style-type: none"> • Timer recording is in progress. 	<p>Timer programming can't be performed when timer recording is in progress. Wait until it finishes.</p>
3. TIMER and  on the front display panel won't stop blinking.	<ul style="list-style-type: none"> • The timer is engaged but there's no cassette loaded. 	<p>Load a cassette with the record safety tab intact, or with the hole covered with adhesive tape.</p>
4. The cassette is automatically ejected, and TIMER and  on the front display panel won't stop blinking.	<ul style="list-style-type: none"> • The loaded cassette has had its record safety tab removed. 	<p>Remove the cassette and cover its hole with adhesive tape, or replace it with a cassette on which the safety tab is intact.</p>
5. TIMER blinks for 10 seconds and the timer mode is disengaged.	<ul style="list-style-type: none"> • TIMER has been pressed when there are no programs in memory, or the timer record program information has not been programmed correctly. 	<p>Check the programmed data and re-program as necessary, then press TIMER again.</p>
6. The cassette is automatically ejected, the power shuts off and TIMER and  won't stop blinking.	<ul style="list-style-type: none"> • The end of tape was reached during timer recording. 	<p>The program may not have been recorded in its entirety. Next time make sure you have enough time on the tape to record the entire program.</p>
7. Cable channels are not automatically switched during timer recording.	<ul style="list-style-type: none"> • The Cable Box Controller is not properly connected to the VCR. • The output channel selected in the Cable Box Output screen is incorrect. • The cable box's power is off. 	<p>Connect the Cable Box Controller correctly (pg. 16).</p> <p>After confirming your cable box's output channel number, re-access the Cable Box Output screen and select the correct number (pg. 18).</p> <p>Make sure the power is on before timer recording starts.</p>

CONTINUED ON NEXT PAGE.



8. Timer recording begins as scheduled, but the channel is always incorrect.	<ul style="list-style-type: none"> ● Even though you don't use an external Cable Box, "CABLE BOX OUTPUT" is set to "ON". 	Set "CABLE BOX OUTPUT" to "OFF" (☞ pg. 17).
9. We moved, and now VCR Plus+ doesn't work properly.	<ul style="list-style-type: none"> ● The receivable stations in the new area are received on different channels than those in the previous area. 	Re-perform the VCR Plus+ setup procedure (☞ pg. 20).
10. "PROGRAM FULL" is displayed on the VCR Plus+ screen.	<ul style="list-style-type: none"> ● All 8 programs of the VCR's timer memory are used. 	Wait until a space in memory clears, or cancel unnecessary program information (☞ pg. 42).

OTHER PROBLEMS

SYMPTOM	POSSIBLE CAUSE	CORRECTIVE ACTION
1. When scanning channels, some of them are skipped over.	<ul style="list-style-type: none"> ● Those channels have been preset to be skipped. 	If you need the skipped channels, restore them (☞ pg. 15).
2. The channel can't be changed.	<ul style="list-style-type: none"> ● Recording is in progress. 	Press PAUSE to pause the recording, change channels, then press PLAY to resume recording.
3. The remote control won't operate my TV.	<ul style="list-style-type: none"> ● The TV/CABLE/VCR switch is set to a position other than TV. 	Set the switch to TV.
4. The remote control won't operate my cable box.	<ul style="list-style-type: none"> ● The TV/CABLE/VCR switch is set to a position other than CABLE. 	Set the switch to CABLE.
5. Even though Auto or Semi-Auto clock setting has been selected, the clock is incorrect.	<ul style="list-style-type: none"> ● The clock setting data received from the Host Channel is incorrect. 	Select a different Host Channel during the Semi-Auto setting procedure (☞ pg. 10), or perform the Manual setting procedure (☞ pg. 11).

ATTENTION:

This recorder contains microcomputers. External electronic noise or interference could cause malfunctioning. In such cases, switch the power off and unplug the power cord. Then plug it in again and switch power on. Take out the cassette. After checking the cassette, operate the unit as usual.



QUESTIONS AND ANSWERS

PLAYBACK

Q. What happens if the end of the tape is reached during playback or search?

A. The tape is automatically rewound to the beginning.

Q. Can the VCR indefinitely remain in the still mode?

A. No. It stops automatically after 5 minutes to protect the heads.

Q. During search, slow, still and frame-by-frame playback, I can't hear any audio. What's the problem?

A. This is normal.

Q. During search, still and frame-by-frame playback, the picture is intermittent. What's the cause?

A. Picture loss occurs when these types of playback are attempted with a tape recorded in LP mode. Pressing **PLAY** to return to normal playback will restore the picture.

Q. When returning from multi-speed search to normal playback, the picture is disturbed. Should I be concerned about this?

A. No, it is normal.

Q. Noise bars appear during multi-speed search. What's the problem?

A. This is normal.

Q. Other than preventing further recording, what effect does removing the safety tab have?

A. It disables marking or erasing of index codes.

Q. Sometimes, during Index Search, the VCR can't find the program I want to see. Why not?

A. There may be index codes too close together.

Q. During playback, on-screen operational indicators sometimes jitter. Why does this happen?

A. If the condition of the tape being played back is not good, jittering of the video (including on-screen indicators) may occur.

RECORDING

Q. When I pause and then resume a recording, the end of the recording before the pause is overlapped by the new recording. Why does this happen?

A. This is normal. It reduces distortion at the pause and resume points.

Q. Can the VCR indefinitely remain in the Record-Pause mode?

A. No. The VCR automatically goes to its Stop mode after 5 minutes to protect the heads. When paused during Instant Timer Recording (ITR), the VCR shuts off automatically after 5 minutes.

Q. What happens if the tape runs out during recording?

A. The VCR automatically rewinds it to the beginning.

TIMER RECORDING

Q. REC and TIMER remain lit on the front display panel. Is there a problem?

A. No. This is a normal condition for a timer recording in progress.

Q. Can I program the timer while I'm watching a tape or a TV broadcast?

A. You won't see the picture as it is replaced by the on-screen menu, but the audio from the program or tape you're viewing is present.



60

SPECIFICATIONS

GENERAL

Power requirement	: AC 120 V \sim , 60 Hz
Power consumption	: 26 W
Temperature	
Operating	: 5°C to 40°C (41°F to 104°F)
Storage	: -20°C to 60°C (-4°F to 140°F)
Operating position	: Horizontal only
Dimensions (W x H x D)	: 400 x 94 x 341 mm (15-3/4" x 3-3/4" x 13-7/16")
Weight	: 4.5 kg (8.2 lbs)
Format	: S-VHS/VHS NTSC standard
Maximum recording time	
SP	: 210 min. with ST-210 video cassette
EP	: 630 min. with ST-210 video cassette

VIDEO/AUDIO

Signal system	: NTSC-type color signal and EIA monochrome signal, 525 lines/60 fields
Recording/ Playback system	: DA-4 (Double Azimuth) head helical scan system
Signal-to-noise ratio	: 45 dB
Horizontal resolution	: 240 lines (VHS) 400 lines (S-VHS)
Frequency range	
Normal audio	: 70 Hz to 10,000 Hz
Hi-Fi audio	: 20 Hz to 20,000 Hz
Input/Output	: RCA connectors (IN x 2, OUT x 1) S-VIDEO connectors (INx1, OUTx1)

TUNER

Tuning system	: Frequency-synthesized tuner
Channel coverage	
VHF	: Channels 2-13
UHF	: Channels 14-69
CATV	: 113 Channels
RF output	: Channel 3 or 4 (switchable; preset to Channel 3 when shipped) 75 ohms, unbalanced

TIMER

Clock reference	: Quartz
Program capacity	: 1-year programmable timer/ 8 programs
Memory backup time	: Approx. 60 min.

ACCESSORIES

Provided accessories	: RF cable (F-type), Infrared remote control unit, "AAA" battery x 2, Cable Box Controller, S-Video cable (4-pin), Audio/Video cable, Mini-plug cable
----------------------	---

Specifications shown are for SP mode unless otherwise specified. E. & O.E. Design and specifications subject to change without notice.





List Of Terms

This guide serves as a quick way to locate frequently used terms and on-screen display names. The first page on which the term appears is listed. Most terms appear more than once in the instruction manual.

A

A/B Code	55
Add Channel	15
AFC	15
Audio Dubbing	52
Audio Monitor	28
Auto Channel Setting	14
Auto Clock Setting	11
Auto Daylight Saving Time	11
Auto Timer	43
Automatic Tracking	27
Aux Input	44
AV Compu Link Playback	32
AV Connection	6

B

Band	13
------------	----

C

Cable Box	16
Cable Box Brand Setting	18
Cable Box Controller	16
Cancel Program	42
Cassette Adapter	23
Check Program	42
Connection to TV	6
Contents	5
Counter Memory	31
Counter Reset	31

D

Delete Channel	15
----------------------	----

E

Editing	44
---------------	----

F

Frame-by-Frame Playback	25
Function Setting	28

G

Guide Channel Map	22
Guide Channel Setting	21

H

Host Channel Selection	10
------------------------------	----

I

Index Search	30
Insert Cassette	23
Insert Editing	48
Instant ReView	31
ITR (Instant Timer Recording)	40

J

Jog Dial	25
----------------	----

L

Language Selection	12
--------------------------	----

M

Main Menu	9
Manual Channel Setting	15
Manual Clock Setting	11
Manual Tracking	27
MBR (Multi-Brand Remote) Code Setting	53

N

Next-Function Memory	32
----------------------------	----

O

On-Screen Display	29
On-Screen Timer Programming	40
On-Screen Timer Recording	40
Override Auto Clock Setting	9

P

PBS Channel	8
Playback	23

R

Record Safety Tab	24
Recording	24
Repeat Playback	27
Reverse Motion Playback	26
Reverse Slow Motion Playback	26
RF Connection	6

S

SAP (Second Audio Program)	35
Second Audio	35
Select Cable Box Output Channel	17
Semi-Auto Clock Setting	10
Shuttle Plus	25
Skip Search	27
Slow Motion Playback	25
Specifications	60
Still Picture Playback	25
SHUTTLE Ring	25
Superimpose	29
S-VHS (Super VHS)	34
S-Video Connection	7

T

Tape Remaining Time	37
Tape Speed Setting	24
Time Zone Selection	10
Tuner Setting	13

V

Variable-Speed Search	26
VCR Plus+	20
VCR Plus+ Timer Programming	38
VCR Plus+ Timer Recording	38

FRONT VIEW

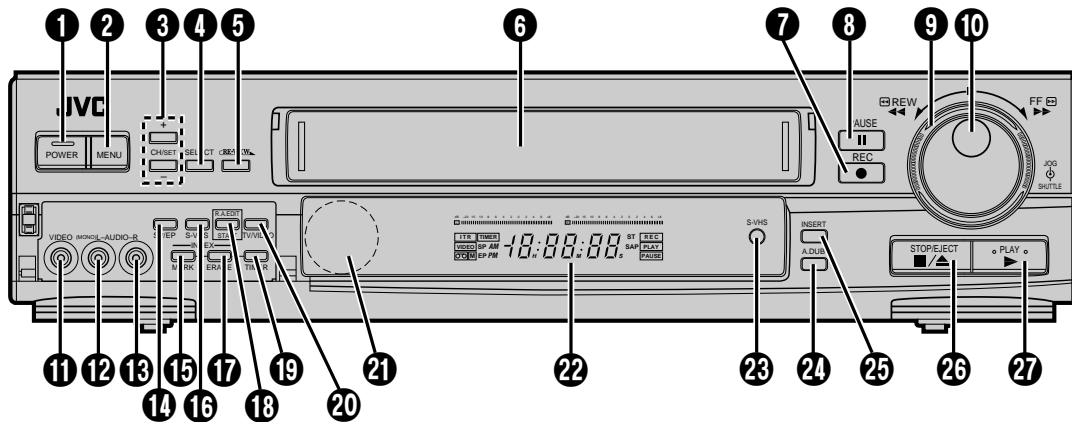

- 1 Power ON/OFF Button (☞ pg. 9)
- 2 Menu Button (☞ pg. 9)
- 3 Channel [CH] +/- Buttons (☞ pg. 24)
- 4 SELECT Button (☞ pg. 9)
- 5 Instant REVIEW Button (☞ pg. 31)
- 6 Cassette Loading Slot
- 7 Record [REC] Button (☞ pg. 24)
- 8 Pause Button (☞ pg. 24)
- 9 SHUTTLE Ring (☞ pg. 23)
- 10 JOG Dial (☞ pg. 25)
- 11 Video Input Connector (☞ pg. 44)
- 12 Mono Audio Input Connector (☞ pg. 44)
- 13 Audio Input Connector [L] (☞ pg. 44)
- 14 Recording Speed [SP/EP] Button (☞ pg. 24)
- 15 INDEX MARK Button (☞ pg. 30)
- 16 S-VHS Button (☞ pg. 34)
- 17 INDEX ERASE Button (☞ pg. 30)
- 18 R.A. EDIT START Button (☞ pg. 51)
- 19 TIMER button (☞ pg. 39)
- 20 TV/VIDEO Button (☞ pg. 9)
- 21 Remote Control Sensor
- 22 Front Display Panel (☞ pg. 63)
- 23 S-VHS indicator (☞ pg. 34)
- 24 Audio Dubbing [A. DUB] Button (☞ pg. 52)
- 25 INSERT Button (☞ pg. 48)
- 26 Stop/Eject Button (☞ pg. 23)
- 27 Play Button (☞ pg. 23)

REAR VIEW

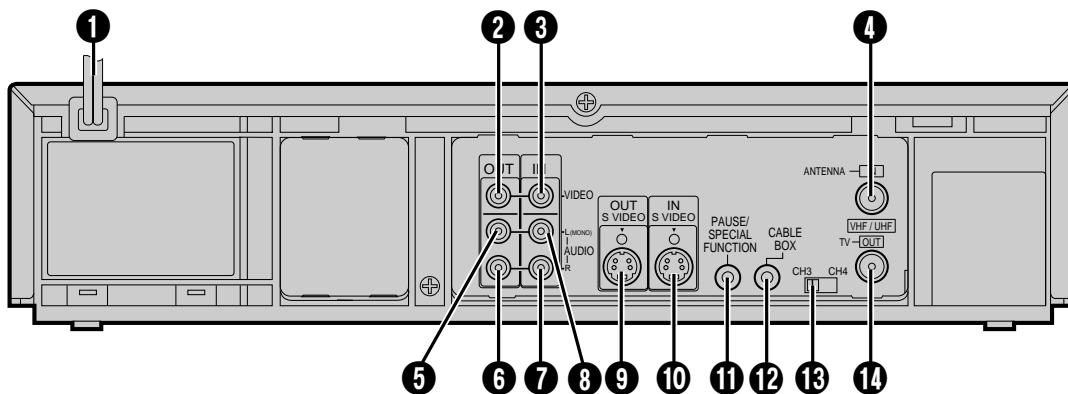

- 1 Power Cord (☞ pg. 6)
- 2 Video Output Connector (☞ pg. 6)
- 3 Video Input Connector (☞ pg. 46)
- 4 ANTENNA IN Connector (☞ pg. 6)
- 5 Audio Output Connector [L] (☞ pg. 6)
- 6 Audio Output Connector [R] (☞ pg. 6)
- 7 Audio Input Connector [R] (☞ pg. 46)
- 8 Audio Input Connector [L] (☞ pg. 46)
- 9 S-Video Output Connector (☞ pg. 7)
- 10 S-Video Input Connector (☞ pg. 46)
- 11 PAUSE/SPECIAL FUNCTION connector
 - Remote PAUSE Connector (☞ pg. 44)
 - AV COMPU LINK Connector (☞ pg. 32)
 - Random Assemble Editing Connector (☞ pg. 50)
- 12 CABLE BOX Connector (☞ pg. 16)
- 13 Channel 3/4 Switch (☞ pg. 6)
- 14 TV OUT Connector (☞ pg. 6)

FRONT DISPLAY PANEL

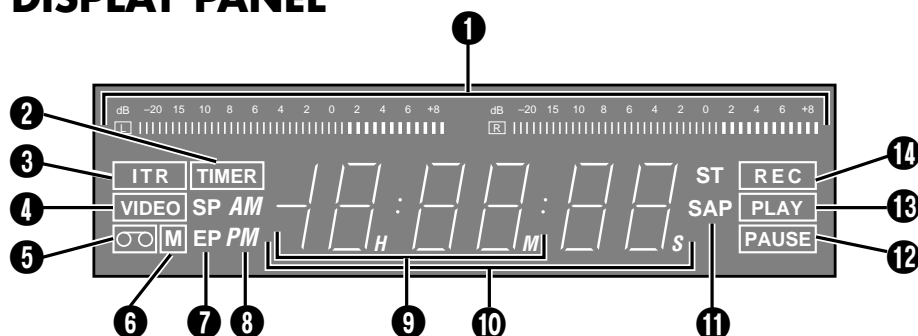

- 1 Audio Level Meter (☞ pg. 36)
- 2 Timer Mode Indicator (☞ pg. 39)
- 3 Instant Timer Recording Indicator (☞ pg. 40)
- 4 Video Mode Indicator (☞ pg. 34)
- 5 "Cassette Loaded" Mark
- 6 Counter Memory Mark (☞ pg. 31)
- 7 Tape Speed Indicators (☞ pg. 24)
- 8 AM/PM Indicators (☞ pg. 8)
- 9 Clock Display (☞ pg. 8)
- 10 Channel Display ["AU" for AUX mode] (☞ pg. 24)
- 11 Multi-Channel TV Sound Indicators (☞ pg. 35)
- 12 Pause Mode Indicator (☞ pg. 24)
- 13 Play Mode Indicator (☞ pg. 23)
- 14 Recording Mode Indicator (☞ pg. 24)

REMOTE CONTROL (Provided)

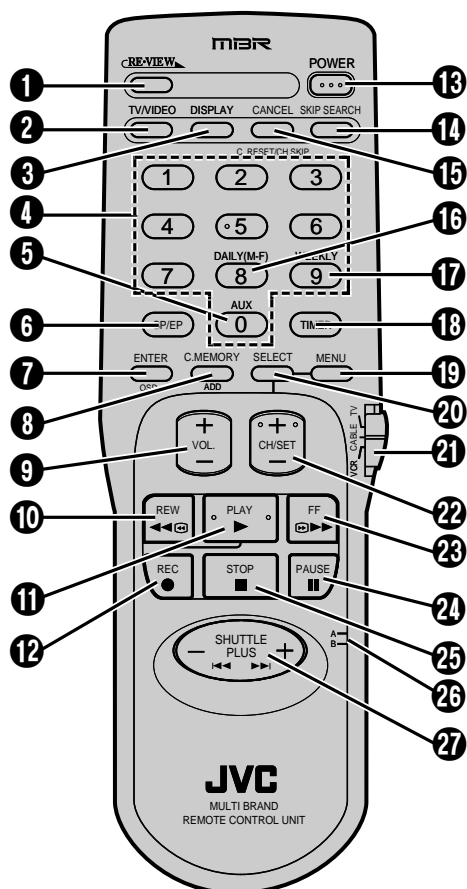

- 1 Instant REVIEW Button (☞ pg. 31)
- 2 TV/VIDEO Button (☞ pg. 34)
- 3 DISPLAY Button (☞ pg. 31)
- 4 DIGIT Buttons (☞ pg. 10)
- 5 "AUX" Mode Select Button (☞ pg. 44)
- 6 Recording Speed [SP/EP] Button (☞ pg. 24)
- 7 ENTER Button (☞ pg. 24)
- 8 Counter [C.] MEMORY Button (☞ pg. 31)
- 9 Volume [VOL] +/- Buttons (☞ pg. 53)
- 10 Rewind [REW] Button (☞ pg. 23)
- 11 PLAY Button (☞ pg. 23)
- 12 Record [REC] Button (☞ pg. 24)
- 13 POWER ON/OFF Button (☞ pg. 9)
- 14 SKIP SEARCH Button (☞ pg. 27)
- 15 CANCEL Button (☞ pg. 42)
- 16 DAILY Timer Recording Button (☞ pg. 38)
- 17 WEEKLY Timer Recording Button (☞ pg. 38)
- 18 TIMER Button (☞ pg. 39)
- 19 MENU Button (☞ pg. 9)
- 20 SELECT Button (☞ pg. 9)
- 21 TV/CABLE/VCR Switch (☞ pg. 53)
- 22 Channel [CH] +/- Buttons (☞ pg. 24)
- 23 Fast-Forward [FF] Button (☞ pg. 23)
- 24 PAUSE Button (☞ pg. 24)
- 25 STOP Button (☞ pg. 23)
- 26 A/B Code Select Switch (☞ pg. 55)
- 27 SHUTTLE PLUS Button (☞ pg. 25)

** If the remote control doesn't work properly, remove its batteries, wait a short time and then try again.

HOW TO LOCATE YOUR JVC SERVICE CENTER

TOLL FREE: 1-800-252-5722

Dear customer:

In order to receive the most satisfaction from your purchase, read the instruction booklet before operating the unit. In the event that repair is necessary, or for the address nearest your location, please refer to the factory service center list below or within the Continental United States, call 1-800-252-5722 for your authorized servicer. Remember to retain your Bill of Sale for Warranty Service.

— JVC

JVC SERVICE & ENGINEERING COMPANY OF AMERICA DIVISION OF US JVC CORP.

FACTORY SERVICE CENTER LOCATIONS

107 Little Falls Road
Fairfield, NJ 07004-2105
(201) 808-9279

1500 Lakes Parkway
Lawrenceville, GA 30243-5357
(770) 339-2522

705 Enterprise Street
Aurora, IL 60504-8149
(708) 851-7855

5665 Corporate Avenue
Cypress, CA 90630-0024
(714) 229-8011

10700 Hammerly, Suite 110
Houston, TX 77043-2310
(713) 935-9331

2969 Mapunapuna Place
Honolulu, HI 96819-2040
(808) 833-5828

230 Eliot Street
Ashland, MA 01721-2377
(508) 881-5923

14505 Commerce Way
Miami Lakes, FL 33016-1512
(305) 362-6252

890 Dubuque Avenue
South San Francisco, CA 94080-1804
(415) 871-2666

Sophisticated electronic products may require occasional service. Just as quality is a keyword in the engineering and production of the wide array of JVC products, service is the key to maintaining the high level performance for which JVC is world famous. The JVC service and engineering organization stands behind our products.

NATIONAL HEADQUARTERS
JVC SERVICE & ENGINEERING COMPANY OF AMERICA
DIVISION OF US JVC CORP.
107 Little Falls Road
Fairfield, NJ 07004-2105

If you ship the product...

Pack your JVC unit in the original carton or one of equivalent size and strength. Enclose, with the unit, a letter stating the problem or symptom that exists and also a copy of the receipt or bill of sale you received when you purchased your JVC unit. Print your home return address on the outside and the inside of the carton. Send to the appropriate JVC Factory Service Center as listed above.

Don't service it yourself.

CAUTION

*To prevent electrical shock, do not open the cabinet. No user serviceable parts inside.
Refer servicing to qualified service personnel.*

ACCESSORIES

*To purchase accessories for your JVC product, you may contact your local JVC Dealer.
Or from the 48 Continental United States call toll free:
1-800-882-2345.*

LIMITED WARRANTY

CONSUMER VIDEO 1-90

JVC COMPANY OF AMERICA warrants this product and all parts thereof, except as set forth below ONLY TO THE ORIGINAL PURCHASER AT RETAIL to be FREE FROM DEFECTIVE MATERIALS AND WORKMANSHIP from the date of original retail purchase for the period as shown below. ("The Warranty Period")

PARTS	1 YR	LABOR	90 DAYS
-------	-------------	-------	----------------

THIS LIMITED WARRANTY IS VALID ONLY IN THE FIFTY (50) UNITED STATES, THE DISTRICT OF COLUMBIA AND IN COMMONWEALTH OF PUERTO RICO.

WHAT WE WILL DO:

If this product is found to be defective, JVC will repair or replace defective parts at no charge to the original owner. Such repair and replacement services shall be rendered by JVC during normal business hours at JVC authorized service centers. Parts used for replacement are warranted only for the remainder of the Warranty Period. All products and parts thereof may be brought to a JVC authorized service center on a carry-in basis except for Television sets having a screen size 25 inches and above which are covered on an in-home basis.

WHAT YOU MUST DO FOR WARRANTY SERVICE:

Return your product to a JVC authorized service center with a copy of your bill of sale. For your nearest JVC authorized service center, please call toll free: (800) 252-5722.

If service is not available locally, box the product carefully, preferably in the original carton, and ship, insured, with a copy of your bill of sale plus a letter of explanation of the problem to the nearest JVC Factory Service Center, the name and location of which will be given to you by the toll-free number.

If you have any questions concerning your JVC Product, please contact our Customer Relations Department.

WHAT IS NOT COVERED:

This limited warranty provided by JVC does not cover:

1. Products which have been subject to abuse, accident, alteration, modification, tampering, negligence, misuse, faulty installation, lack of reasonable care, or if repaired or serviced by anyone other than a service facility authorized by JVC to render such service, or if affixed to any attachment not provided with the products, or if the model or serial number has been altered, tampered with, defaced or removed;
2. Initial installation and installation and removal for repair;
3. Operational adjustments covered in the Owner's Manual, normal maintenance, video and audio head cleaning;
4. Damage that occurs in shipment, due to act of God, and cosmetic damage;
5. Signal reception problems and failures due to line power surge;
6. Video Pick-up Tubes/CCD Image Sensor, Cartridge, Stylus (Needle) are covered for 90 days from the date of purchase;
7. Accessories;
8. Batteries (except that Rechargeable Batteries are covered for 90 days from the date of purchase); from the date of purchase);

There are no other express warranties except as listed above.

THE DURATION OF ANY IMPLIED WARRANTIES INCLUDING THE IMPLIED WARRANTY OF MERCHANTABILITY, IS LIMITED TO THE DURATION OF THE EXPRESS WARRANTY HEREIN.

JVC SHALL NOT BE LIABLE FOR THE LOSS OF USE OF THE PRODUCT, INCONVENIENCE, LOSS OR ANY OTHER DAMAGES, WHETHER DIRECT, INCIDENTAL OR CONSEQUENTIAL (INCLUDING, WITHOUT LIMITATION, DAMAGE TO TAPES, RECORDS OR DISCS) RESULTING FROM THE USE OF THIS PRODUCT, OR ARISING OUT OF ANY BREACH OF THIS WARRANTY. ALL EXPRESS AND IMPLIED WARRANTIES, INCLUDING THE WARRANTIES OF MERCHANTABILITY AND FITNESS FOR PARTICULAR PURPOSE, ARE LIMITED TO THE WARRANTY PERIOD SET FORTH ABOVE.

Some states do not allow the exclusion of incidental or consequential damages or limitations on how long an implied warranty lasts, so these limitations or exclusions may not apply to you. This warranty gives you specific legal rights and you may also have other rights which vary from state to state.

JVC COMPANY OF AMERICA
DIVISION OF US JVC CORP.

41 Slater Drive
Elmwood Park, New Jersey 07407

REFURBISHED PRODUCTS CARRY A SEPARATE WARRANTY, THIS WARRANTY DOES NOT APPLY. FOR DETAILS OF REFURBISHED PRODUCT WARRANTY, PLEASE REFER TO THE REFURBISHED PRODUCT WARRANTY INFORMATION PACKAGED WITH EACH REFURBISHED PRODUCT.

For customer use:

Enter below the Model No. and Serial No. which is located either on the rear, bottom or side of the cabinet. Retain this information for future reference.

Model No.: _____

Serial No.: _____

Purchase date: _____

Name of dealer: _____

EN

HR-S5300U

JVC
VICTOR COMPANY OF JAPAN, LIMITED